

Thermoplastic Piping Technical Manual

Chemtrol

PVC, CPVC, PP, PVDF

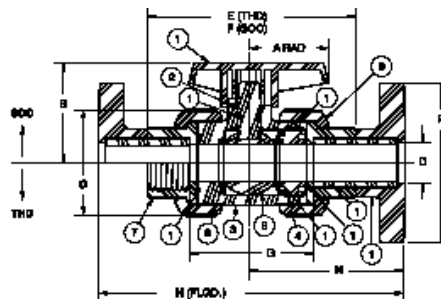

Introduction	1
Materials	1
Materials	1
Physical Properties of Thermoplastic Piping Materials	2
Standards	3
Engineering Data	4
Dimensions and Reference Data – Schedule 80 Pipe and Fittings	4
Dimensions and Reference Data – Pipe Threads and Flanges	5
Metric Conversion Tables	6
Engineering Design	7
Pressure and Temperature Ratings of Chemtrol Products	7
Pressure Ratings/Pressure Losses	8
Flow and Friction Loss Chart for Schedule 40	9
Flow and Friction Loss Chart for Schedule 80	10
Hydraulic Shock/Surge Wave Method	11
Expansion and Thermal Contraction of Plastic Pipe	12
Managing Expansion/Contraction in System Design	13
Pipe Support Spacing	14
Installation Instructions	15
Storage, Handling and Joining Methods	15
Preparation of Pipe and Fittings	16
Solvent Cement Joining	17
Thermo-Seal (Socket Fusion) – Materials and Tools	20
Thermo-Seal (Socket Fusion) – Hand-Held Heat-Tools, Bench Mount Joining	22
Flanged Joints	29
Repairing Thermoplastic Pipe Joints	29
Threading Instructions	30
Ultraviolet Radiation	31
Underground Installation	32
Product Line	34
Product Specifications	36
PVC Schedule 80 Pipe and Fittings	36
CPVC Schedule 80 Pipe and Fittings	36
Polypropylene Schedule 80 Pipe and Fittings	37
Polyvinylidene Fluoride (PVDF) Schedule 80 Pipe and Fittings	37
Tru-Bloc, True Union Ball Valves	38
Bleach Ball Valve	38
Ball Check and Foot Valves	39
Model "B" Butterfly Valve	39
Model "C" Butterfly Valve	40
PVC Specialty Valves	40
Warranty	41

Copies of the Thermoplastic Piping Technical Manual and other Chemtrol publications are available for download on www.nibco.com/chemtrol.

Do not use or test the products in this catalog with compressed air or other gases. See Chemtrol Chem-Aire[®] literature for information about shatter-resistant thermoplastic piping systems specifically designed for compressed air and other gases.

Introduction to Chemtrol Valves

With more than 40 years of experience in industrial thermoplastics, Chemtrol offers dependable products that work in the most demanding environments.

For specific recommendations of chemical compatibility, see the *Chemtrol Chemical Resistance Guide*. For a wide variety of thermoplastic valves of superior design and quality, see the *Chemtrol Valve Guide*. For the best thermoplastic fittings and flanges available for industrial use, refer to the *Chemtrol Fitting Guide*. For thermoplastic piping systems specifically designed for compressed air and other gases, refer to the *Chemtrol Chem-Aire® Guide*. These publications are available for download on www.nibco.com/chemtrol in PDF format.

Materials

PVC

(Polyvinyl Chloride) PVC conforming to ASTM D 1784, Classification 12454 B, formerly designated Type I, Grade 1, is the most frequently specified of all thermoplastic piping materials. It has been used successfully for over 45 years in such diverse areas as chemical processing, industrial plating, chemical drainage, fresh and wastewater treatment, chilled and tower cooling water, deionized water manufacture and distribution, and irrigation sprinkler systems. PVC is characterized by high physical properties and resistance to chemical attack by strong acids and other oxidizers, alkalis, salt solutions, some organic chemical solutions, and many other chemicals. However, it is attacked by non-ionic surfactants, some vegetable oils (e.g., peanut), and many organic chemicals such as polar solvents (e.g., ketones), aromatics (i.e., benzene ring structure), and chlorinated hydrocarbons. The maximum service temperature of PVC is 140° F. With a design stress of 2,000 psi at 73° F, the long-term hydrostatic strength of PVC is as high as any of the major thermoplastic materials being used for solid piping systems. PVC is joined by solvent cementing, threading, or flanging.

CPVC (Corzan®)

(Chlorinated Polyvinyl Chloride) CPVC conforming to ASTM D 1784, Classification 23447-B, formerly designated Type IV, Grade 1, is a resin created by the post-chlorination of a PVC polymer. The material's resistance to chemical attack is almost identical to that of PVC. And the physical properties of CPVC are very similar to those of PVC at 73° F, but the additional chlorine in the CPVC polymer extends its maximum service temperature from 140° F to 210° F. For example, the design stress for CPVC is 2,000 psi at 73° F, identical to that of PVC. But its strength is only reduced to 500 psi at 180° F, as compared to 440 psi for PVC at 140° F. For more than 35 years, CPVC has proven to be an excellent material for hot corrosive liquids, hot and cold water distribution, and similar applications above the useful temperature range for PVC. CPVC may even be chosen over PVC in the 110° F to 140° F temperature range because its higher strength-at-temperature, requiring less frequent piping supports, can translate to a more favorable overall installed cost than PVC. CPVC is joined by solvent cementing, threading, or flanging.

PVDF (Kynar®)

(Polyvinylidene Fluoride) PVDF homopolymer conforming to ASTM D 3222, Type I, Grade 2, is a tough, abrasion-resistant fluorocarbon material that has a design stress of 1,360 psi at 73° F and a maximum service temperature of 280° F. It has versatile chemical resistance to salts, strong acids, dilute bases, and many organic solvents, such as the aromatics (i.e., benzene ring structure), the aliphatics (i.e., paraffin, olefin, and acetylene hydrocarbons), and the chlorinated groups. And PVDF is ideally suited for handling wet or dry chlorine, bromine, and other halogens. However strong bases, hypochlorites, and some organic chemicals such as polar solvents (e.g., ketones) and esters attack it. No other solid thermoplastic piping material can approach the combined strength, working temperature, and chemical resistance characteristics of PVDF. It is joined by the thermo-sealing socket fusion process, threading, or flanging.

The basic PVDF resin is essentially transparent to ultraviolet (UV) radiation, and the plastic material is not degraded by sunlight. However, the fluid medium in a PVDF piping system could be exposed to UV radiation. To provide protection against UV degradation of the fluid medium, an FDA-approved red pigmentation is added to all piping components for general industrial consumption, particularly for outdoor installations. Conversely, in certain industries, such as electronics, pharmaceutical, and processed foods and beverages, PVDF has become the piping material of choice because of its high purity, low surface and joint extractables, and elevated temperature sanitation capability. For these applications, another line of piping products made from natural (unpigmented) Kynar is available.

PP

(Polypropylene) PP as specified by ASTM D 4101, is a member of the polyolefin family of pure hydrocarbon plastics. Although PP has half the strength of PVC and CPVC, with a design stress of 1,000 psi at 73° F, it may have the most versatile chemical resistance of the thermoplastic materials identified as the sentinels of industrial piping. Consider the fact that there are no known solvents for PP. As a result, it has been the material of choice for drainage of mixed industrial chemicals for over 40 years. As pressure piping, PP has no peers for concentrated acetic acid or hydroxides. It is also suitable for milder solutions of most acids, alkalis, salts, and many organic chemicals, including solvents. The nemeses for PP are strong oxidizers, such as the hypochlorites and higher concentrations of sulfuric, nitric, and hydrofluoric acids. They are Environmental Stress Cracking (ESC) agents for PP, meaning that time-to-failure is a function of the combined variables of concentration and temperature of the fluid and stress in the piping material. Although PP is not recommended for some organic chemicals, such as polar and chlorinated solvents and the aromatics, the concern is permeation through rather than catastrophic damage of the molecular chain.

All polyolefins are severely degraded by ultraviolet (UV) radiation. However, the plastic piping industry recognizes that PP compounds, containing more than 2 1/2% carbon black pigmentation, are adequately UV stabilized to realize an outside service life of more than 25 years. Chemtrol utilizes such a compound to make all piping components for general industrial consumption, particularly for outdoor installations. Because of the high purity and low surface and joint extractables from natural (unpigmented) PP, Chemtrol utilizes an optimum compound to also make piping components for DI water systems. These are intended as an economic alternative to the ultra high purity infrared (IR) butt fusion PVDF systems typically found in the highly sophisticated electronic semi-conductor industry. It has been demonstrated that an appropriately designed serpentine system, constructed by mechanics properly instructed in the heat fusion of socket joints for sanitary piping, can consistently produce water conforming to the quality standards for injectable drugs.

FPM

(Fluoroelastomer) FPM produced from Viton® and Fluorel® compounds, is compatible with a broad spectrum of chemicals. Because of this extensive chemical compatibility, spanning wide ranges of concentration and temperature, FPM has gained wide acceptance as a material of construction for valve "O"-rings and seats. These fluoroelastomers can be used in most applications involving mineral acids (with the exception of HCl), salt solutions, chlorinated hydrocarbons, and petroleum oils. FPM is not recommended for most strong alkali solutions.

EPDM

(Also known as EPT) EPDM produced from ethylene-propylene-diene monomer, is a terpolymer elastomer that has good abrasion and tear resistance and offers excellent chemical resistance to a variety of salt, acidic, and organic chemical solutions. It is the best material for most alkali solutions and hydrochloric acid, but is not recommended for applications involving petroleum oils or most strong acids.

TFE

(Polytetrafluoroethylene) PTFE typically produced from Teflon®, has outstanding resistance to chemical attack by most chemicals and solvents. PTFE has a temperature rating of -200° F to +500° F. It is a self-lubricating material used as a seat and/or bearing material in most Chemtrol valves.

CR

(Neoprene®) CR was the first commercial synthetic rubber. It is a moderately oil-resistant material with good general chemical resistance. It is specifically recommended for strong concentrations of alkalis, but not recommended for most organic solvents or any acid solutions, other than dilute.

Fluorel®, a registered trademark of 3M Company
Kynar®, a registered trademark of ATOFINA Chemicals Inc.
Neoprene®, a registered trademark of E.I. DuPont Co.
Teflon®, a registered trademark of E.I. DuPont Co.
Viton®, a registered trademark of DuPont Dow Elastomers
Corzan®, a registered trademark of B.F. Goodrich

Physical Properties
of Thermoplastic Piping Materials

ASTM Test Methods	Properties	Material			
		PVC 12454-B	CPVC 23447-B	PVDF	Polypropylene
General					
D 792	Specific Gravity	1.38	1.50	1.76	.905
D 570	Water Absorption % 24 Hrs. @ 73° F	.05	.05	.04	.02
Mechanical					
D 638	Tensile Strength psi @ 73° F	7,300	7,200	6,000	4,600
D 638	Modulus of Elasticity in Tension psi @ 73° F x 10 ⁵	4.2	3.7	2.1	2.0
D 790	Flexural Strength psi	14,500	15,600	9,700	7,000
D 256	Izod Impact Strength @ 73° F (Notched)	1.1	2.0	3.8	.8
Thermal					
D 696	Coefficient of Thermal Expansion in/in/° F x 10 ⁻⁵	3.0	3.8	7.9	5.0
C 177	Thermal Conductivity BTU/HR/Sq. Ft./° F/in	1.2	.95	.79	1.2
D 648	Heat Distortion Temp. ° F @ 66 psi	NA	NA	284	195
D 648	Heat Distortion Temp. ° F @ 264 psi	163	212	194	140
	Resistance to Heat ° F at Continuous Drainage	140	210	280	180
Flammability					
D 2863	Limiting Oxygen Index (%)	43	60	44	17
E 84	Flame Spread (%)	15-20	15	0	NA
E 84	Smoke Generation	>300	>350	50	>400
	Underwriters Lab Rating (Sub. 94)	94V-0	94V-0	94V-0	94HB

Many commercial, industrial, and governmental standards or specifications are available to assist the design engineer in specifying plastic piping systems. Standards most frequently referenced in plastic piping specifications are ASTM Standards. These standards also often form the bases of other standards in existence. Below is a list and description of those standards most typically applied to industrial plastic piping.

**ASTM Standard D 1784
(American Society for Testing and Materials)**

This standard covers PVC and CPVC compounds used in the manufacture of plastic pipe, valves, and fittings. It provides a means for selecting and identifying compounds on the basis of a number of physical and chemical criteria. Conformance to a particular material classification in this standard requires meeting a number of minimum physical and chemical properties.

ASTM Standard D 4101 (formerly was D 2146)

This standard covers the polymeric content and physical characteristics of PP (polypropylene) plastic materials for injection molding and extrusion.

ASTM Standard D 3222

This standard covers the polymerization method and physical properties of PVDF (polyvinylidene fluoride) fluoroplastic materials for molding and extrusion.

ASTM Standards D 1785 and F 441

These standards cover the definition and quality aspects of Schedule 40, 80, and 120 PVC (D 1785) and CPVC (F 441) pressure pipe. Outlined in these standards are dimensional requirements, minimum burst and sustained pressure requirements, maximum operating pressure, and test procedures for determining pipe quality with respect to workmanship and materials.

ASTM Standard D 2466

This standard covers Schedule 40 PVC threaded and socket pressure fittings. The standard stipulates thread and socket specifications as well as minimum lengths, wall thicknesses, burst pressures, material classification, quality, and requirements for marking identification.

ASTM Standards D 2464 and F 437

Until recently, these standards covered PVC (D 2464) and CPVC (F 437) Schedule 80 threaded pressure fitting. Thread dimensional specifications, minimum wall thickness and burst pressure, material classification, and requirements for marking identification were stipulated. However, the requirements for Schedule 80 threaded fittings have now been rolled into the respective standards for Schedule 80 Socket Type Pressure Fittings, and the threaded-only standards will be deleted.

ASTM Standards D 2467 and F 439

These standards now cover Schedule PVC (D 2467) and CPVC (F 439) Socket Type, as well as Threaded Pressure Fittings. They formerly covered only Socket Type fittings. Dimensions, thread gaging, minimum wall thickness and burst pressure, material classification, various quality aspects and requirements for marking identification are stipulated.

ASTM Standard F 1970

This specification covers special engineered fittings or appurtenances for use in PVC or CPVC systems. Flanges, unions, and valves not included in the scope of other ASTM specifications are specifically referenced. Minimum requirements are identified for testing, materials, dimensions, marking, and in-plant quality control.

ASTM Standard F 1498

This specification adapts the General Purpose American Pipe Thread Specification, ASME B1.20.1, to taper pipe threads for use on plastic pipe and fittings with machined or molded threads. The standard covers dimensions and gaging of plastic tapered National Pipe Threads (NPT) for leak-tight joints, and it is now referenced in all ASTM Standards for plastic piping products.

ASTM Standard D 2855

This standard describes the procedure for making joints with PVC pipe and fittings by means of solvent cementing.

ASTM Standard D 2657

This standard covers the procedures for the heat joining of pipe and fittings made from polyolefin materials utilizing either the socket or butt fusion methods.

ASTM Standard F 656

This standard covers the requirements for primers to be used in conjunction with solvent cement for the chemical fusion of PVC pipe and fitting joints.

ASTM Standards D 2564 and F 493

These standards set forth requirements for PVC (D 2564) and CPVC (F 493) Solvent Cement. The specification identifies the resin compound to be used and stipulates minimum resin content, solution viscosities, and physical performance qualities.

ASTM Standard D 1599

This standard covers the test method for establishing the short-term hydraulic failure pressure of thermoplastic pipe, tubing, and fittings under specific temperature, time, and method of loading conditions. These test techniques are normally used for quality control.

ASTM Standard D 2837

This standard describes the procedure for obtaining the Hydrostatic Design Stress (maximum working strength) for any thermoplastic pipe material at any practical temperature. This is accomplished by evaluating long-term stress rupture data, tested in conformance with ASTM D 1598, on pipe made from the material. It also specifies the methods for mathematical analysis and treatment of the data.

Organizations other than ASTM issue standards that are commonly encountered in industrial thermoplastic piping design. The most important of these are described below.

**ASME B1.20.1 (formerly American Standards Association B2.1)
(American Society of Mechanical Engineers)**

This specification details the dimensions and gaging methods for tapered pipe threads. It was originally developed for metallic joints, but it is now also referenced in the ASTM standard for plastic fittings cited above. See page 5 for excerpted details.

ASME B16.5

This specification sets forth the dimensional requirements for 150# steel flanges and flanged fittings. The bolt hole pattern and outside diameter dimensions were adopted for plastic flanges manufactured in the U.S.A. See page 5 for pertinent details.

ANSI/NSF STANDARD 14

(American National Standards Institute/National Sanitation Foundation International)

This standard establishes minimum physical and performance requirements for plastic piping components and associated materials. It provides definitions and requirements for materials, ingredients, products, quality assurance, marking, and record keeping. Products that are tested and certified by NSF, except those specifically exempted by policy, must bear an NSF listing mark which identifies the intended application. The NSF listing marks for plastic piping components certified under Standard 14 include: potable water (NSF-pw), corrosive waste (NSF-cw), tubular continuous waste (NSF-tubular), and drain, waste & vent (NSF-dww). The "NSF-pw" mark denotes certification to Standard 14 for both performance and health effects (ANSI/NSF 61).

ANSI/NSF Standard 61

This standard was developed to establish minimum requirements for the control of potential adverse health effects from chemical contaminants and impurities that are indirectly imparted to drinking water systems from products, components, and materials used in these systems. It is intended that this standard cover specific materials or products that come into contact with drinking water, treatment chemicals for drinking water, or both. The products and materials covered include, but are not limited to: process media (carbon, sand, etc.), protective materials (coatings, linings, liners, etc.), joining and sealing materials (solvent cements, welding materials, gaskets, etc.), pipes and related products (pipes, tanks, fittings, etc.), mechanical devices used in treatment/transmission/distribution systems (valves, chlorinators, separation membranes, etc.), and mechanical plumbing devices (faucets, endpoint control valves, etc.). To show compliance to this standard, a manufacturer must allow third-party certification by an ANSI-recognized testing laboratory. Chemtrol products have been tested by NSF International. Products that have been approved to the requirements of ANSI/NSF 61 display the "NSF-61" or "NSF-pw" mark on the product, packaging, or both.

Technical assistance regarding standards, applications, product performance, design, and installation tips is available by calling the Technical Services Hotline – 888-446-4226. Fax: 888-336-4226.

Dimensions and Reference Data—Schedule 80

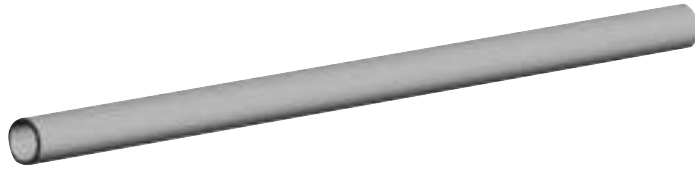

Pipe¹ 20 ft. Lengths

Nominal Pipe Size	Approximate Weight per 100 ft.				Nom. Outside Diameter (In.)	Nom. Inside Diameter (In.)	Wall Thickness (in.)		Cross-sectional Area (in. ²)	Internal Area (in. ²)	Fluid Capacity (gal/100ft.)	Outside Surf. Area (ft ² /100ft)	Threshold Flow ² (GPM)
	PVC	CPVC	Polypropylene	PVDF			Nom.	Min.					
1/4	10.1	11.9	—	—	.540	.282	.129	.119	.167	.062	.32	14.14	.97
1/2	20.5	24.3	14.0	24.4	.840	.526	.157	.147	.337	.217	1.13	21.99	3.39
3/4	27.8	32.9	18.9	33.0	1.050	.722	.164	.154	.457	.409	2.13	27.49	6.38
1	40.4	48.5	27.1	48.7	1.315	.936	.1895	.179	.670	.688	3.57	34.43	10.72
1 1/4	56.7	66.9	37.9	—	1.660	1.255	.2025	.191	.927	1.237	6.43	43.46	19.28
1 1/2	68.9	81.1	44.8	81.4	1.900	1.476	.212	.200	1.124	1.711	8.89	49.74	26.67
2	94.9	108.5	62.3	112.6	2.375	1.913	.231	.218	1.556	2.874	14.93	62.18	44.79
2 1/2	144.9	165.4	—	—	2.875	2.290	.2925	.276	2.373	4.119	21.40	75.27	64.19
3	193.8	221.3	126.6	256.4	3.500	2.864	.318	.300	3.179	6.442	33.47	91.63	100.40
4	283.3	323.4	185.2	357.0	4.500	3.786	.357	.337	4.647	11.258	58.48	117.81	175.44
6	541.1	616.8	359.9	714.3	6.625	5.709	.458	.432	8.873	25.598	132.98	173.44	398.93
8	821.9	905.8	—	—	8.625	7.565	.530	.500	13.479	44.948	233.49	225.80	700.48
10	1227.7	—	—	—	10.750	9.493	.6285	.593	19.985	70.778	367.68	281.43	1103.02
12	1710.4	—	—	—	12.750	11.294	.726	.687	27.495	100.181	520.79	333.79	1562.36

1 Dimensions shown are listed in ASTM D-1785 and F-441 for PVC and CPVC Schedule 80 plastic pipe, respectively.

2 Upper threshold rate of flow = 5 ft./sec. fluid velocity.

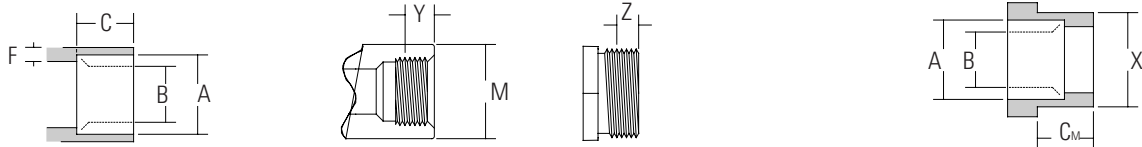

Fittings¹

Size	IPS Dia	Solvent Socket (S)			Female Threads (FPT) ¹		Male Threads (MPT)	Male End (SPG)		Wall Thickness	
		A ²	B ²	C ² Nom	Y ²	M ² Min	Z ²	X	Cm ⁴ Nom	F ⁴ Min	E ⁴ Min
1/4	.540	.552	.536	.640	.311	.840	.311	.540	.655	.149	.119
1/2	.840	.848	.836	.890	.427	1.280	.427	.840	.905	.185	.147
3/4	1.050	1.058	1.046	1.015	.446	1.500	.446	1.050	1.030	.195	.154
1	1.315	1.325	1.310	1.140	.530	1.810	.530	1.315	1.155	.225	.179
1 1/4	1.660	1.670	1.655	1.265	.550	2.200	.550	1.660	1.280	.240	.191
1 1/2	1.900	1.912	1.894	1.390	.550	2.500	.550	1.900	1.405	.250	.200
2	2.375	2.387	2.369	1.515	.566	2.375	.566	2.375	1.530	.275	.218
2 1/2	2.875	2.889	2.868	1.780	.870	3.560	.870	2.875	1.810	.345	.276
3	3.500	3.516	3.492	1.905	.954	4.300	.954	3.500	1.933	.375	.300
4	4.500	4.518	4.491	2.280	1.032	5.430	1.032	4.500	2.310	.420	.337
6	6.625	6.647	6.614	3.030	—	—	—	6.625	3.060	.540	.432
8	8.625	8.655	8.610	4.500	—	—	—	8.625	4.590	.625	.500
10	10.750	10.780	10.735	5.500	—	—	—	10.750	5.590	.741	.593
12	12.750	12.780	12.735	6.500	—	—	—	12.750	6.590	.859	.687

1 With exception of thread lengths, dimensions shown are listed in ASTM D-2467 and F-439 for PVC and CPVC socket-type Schedule 80 fittings, respectively.

2 Dimensions shown are typical male component engagement, hand-tight (L1 in ANSI B1.20.1 thread spec.) plus 1 1/2 turns lightening.

3 Dimensions shown are not applicable for polypropylene or PVDF. Socket diameters in these materials are designed for Chemtrol thermo-seal socket fusion joining.

4 Chemtrol fittings may exceed certain minimum ASTM dimensional requirements in order to ensure functional satisfaction.

5 Dimensions are listed in ASTM D-2464 and F-437 for PVC and CPVC threaded Schedule 80 fittings, respectively.

Dimensions and References—Pipe Threads, Flanges, and Pressure Conversion Factors

American Standard Taper Pipe Thread, NPT (excerpt from ANSI B1.20.1)

Nominal Size	Outside Diameter D	Number of Threads Per Inch n	Pitch of Thread p	Normal Engagement By Hand L ₁	Length of Effective Thread L ₂	Wrench Makeup Length for Internal Thread L ₃	Total Length: End of Pipe to Vanish Point L ₄	Pitch Diameter at Beginning of External Thread E ₀	Pitch Diameter at Beginning of Internal Thread E ₁	Height of Thread (Max.) h
1/4	0.540	18	.05556	.228	.4018	.1667	.5946	.47739	.49163	.04444
1/2	0.840	14	.07143	.320	.5337	.2143	.7815	.75843	.77843	.05714
3/4	1.050	14	.07143	.339	.5457	.2143	.7935	.96768	.98887	.05714
1	1.315	11 1/2	.08696	.400	.6828	.2609	.9845	1.21363	1.23863	.06957
1 1/4	1.660	11 1/2	.08696	.420	.7068	.2609	1.0085	1.55713	1.58338	.06957
1 1/2	1.900	11 1/2	.08696	.420	.7235	.2609	1.0252	1.79609	1.82234	.06957
2	2.375	11 1/2	.08696	.436	.7565	.2609	1.0582	2.26902	2.29627	.06957
2 1/2	2.875	8	.12500	.682	1.1375	.2500	1.5712	2.71953	2.76216	.10000
3	3.500	8	.12500	.766	1.2000	.2500	1.6337	3.34062	3.38850	.10000
4	4.500	8	.12500	.844	1.3000	.2500	1.7337	4.33438	4.38712	.10000

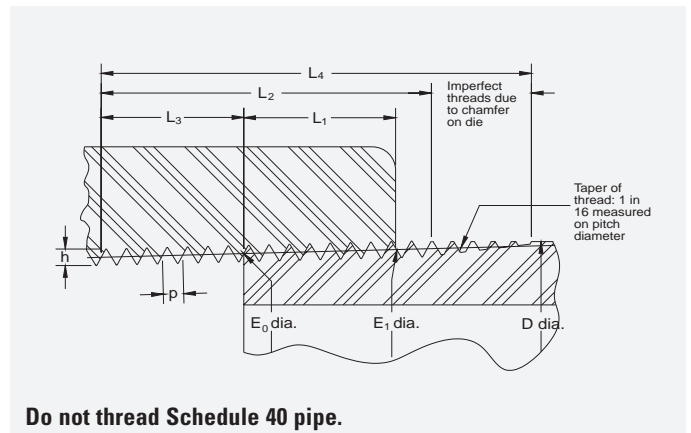

Do not thread Schedule 40 pipe.

ANSI B16.5 Dimensional Data – Flanges and Flanged Fittings

Nominal Pipe Size (In.)	Outside Diameter (In.)	Number of Holes	Drilling	
			Diameter of Bolt (In.)	Diameter of Bolt Circle (In.)
1/2	3.50	4	1/2	2.38
3/4	3.88	4	1/2	2.75
1	4.25	4	1/2	3.12
1 1/4	4.62	4	1/2	3.50
1 1/2	5.00	4	1/2	3.88
2	6.00	4	5/8	4.75
2 1/2	7.00	4	5/8	5.50
3	7.50	4	5/8	6.00
4	9.00	8	5/8	7.50
6	11.00	8	3/4	9.50
8	13.50	8	3/4	11.75
10	16.00	12	7/8	14.25
12	19.00	12	7/8	17.00

‡ Dimensions and bolts conform to ANSI B16.5 for 150 lb. steel flanges. Bolt holes are 1/8" larger in diameter than the required bolts.

Metric Equivalent Charts

Linear Conversion Table From Fractional Inches to Millimeters

inches		mm	inches		mm
1/64	.016	.397	33/64	.516	13.097
1/32	.031	.794	17/32	.531	13.494
3/64	.047	1.191	35/64	.547	13.891
1/16	.063	1.588	9/16	.563	14.288
5/64	.078	1.984	37/64	.578	14.684
3/32	.094	2.381	19/32	.594	15.081
7/64	.109	2.778	39/64	.609	15.478
1/8	.125	3.175	5/8	.625	15.875
9/64	.141	3.572	41/64	.641	16.272
5/32	.156	3.969	21/32	.656	16.669
11/64	.172	4.366	43/64	.672	17.066
3/16	.188	4.763	11/16	.688	17.463
13/64	.203	5.159	45/64	.703	17.859
7/32	.219	5.556	23/32	.719	18.256
15/64	.234	5.953	47/64	.734	18.653
1/4	.250	6.350	3/4	.750	19.050
17/64	.266	6.747	49/64	.766	19.447
9/32	.281	7.144	25/32	.781	19.844
19/64	.297	7.541	51/64	.797	20.241
5/16	.313	7.938	13/16	.813	20.638
21/64	.328	8.334	53/64	.828	21.034
11/32	.344	8.731	27/32	.844	21.431
23/64	.359	9.128	55/64	.859	21.828
3/8	.375	9.525	7/8	.875	22.225
25/64	.391	9.922	57/64	.891	22.622
13/32	.406	10.319	29/32	.906	23.019
27/64	.422	10.716	59/64	.922	23.416
7/16	.438	11.113	15/16	.938	23.813
29/64	.453	11.509	61/64	.953	24.209
15/32	.469	11.906	31/32	.969	24.606
31/64	.484	12.303	63/64	.984	25.003
1/2	.500	12.700	1	1.000	25.400

English to Metric Conversion Table

Units	Change to	Multiply by
Inches	Millimeters	25.40
Inches	Centimeters	2.54
Inches	Meters	.0254
Feet	Meters	.3048
Miles	Kilometers	1.609347
Sq. Inches	Sq. Centimeters	6.452
Sq. Feet	Sq. Meters	.0929
Cu. Inches	Cu. Centimeters	16.3872
Cu. Feet	Cu. Meters	.02832
U.S. Gallons	Liters	3.7854
Pounds	Kilograms	.45359

Temperature Conversion

$F = C \times 1.8 + 32$ $C = (F - 32) \div 1.8$

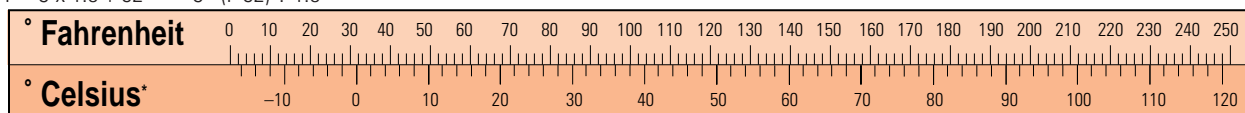

* Formerly known as Centigrade.

Pressure Conversion Factors

Pressure measurements are based on the standardized weight of water expressed in a variety of English and metric units.

1 psig (gauge)	=	2.3068	foot of water head
	=	2.036	inch of mercury head
	=	0.0689	bar
	=	0.0703	kgm/cm ² (kilograms/centimeter ²)
	=	6894.757	N/m ² (newton/meter ²)
	=	6.8948	kPa (kilopascal)
1 foot of water	=	0.4335	psig
	=	0.0305	kgm/cm ² (kilograms/centimeter ²)
	=	2988.8837	N/m ² (newton/meter ²)
	=	0.33457	kPa (kilopascal)
	=	0.02989	bar
1 bar	=	100000.0	N/m ² (newton/meter ²)
	=	14.50377	psig
	=	100.0	kPa (kilopascal)
	=	10197.1621	kgm/cm ² (kilograms/centimeter ²)
	=	33.456	foot of water head
1 N/m ² (newton/meter ²)	=	1.0	Pa (pascal) = 0.001 kPa (kilopascal)
	=	0.000010197	kgm/cm ²
	=	0.000145	psig (gauge)
1 kilogram/centimeter ²	=	98066.5	N/m ² (newton/meter ²)
	=	14.2233	psig

Vacuum Conversion Factors

Vacuum may be thought of as the absence of pressure. It is the measure of negative pressure between standardized atmospheric pressure and a theoretically perfect vacuum.

1 Std. Atmosphere	=	14.6959	psia (absolute)
	=	760.0	mm (millimeter) of mercury head
	=	1.0332276	kgm/cm ² (kilograms/centimeter ²)
	=	1.01325	bar
	=	101.325	kPa (kilopascal)
1 mm	=	0.03937	inch
1 micron of mercury	=	0.001	mm (millimeter) of mercury head
	=	0.000019336	psig (gauge)
1 mm of mercury	=	1000.0	micron of mercury head
1 inch	=	25.4	mm (millimeter)
1 inch of mercury	=	25400.0	micron of mercury head
	=	0.4912	psig
1 inch of water	=	0.0361	psig
	=	1868.2742	micron of mercury head
1 psig (gauge)	=	27.6817	inch of water head

Pressure Ratings of Chemtrol Products

The pressure carrying capability of any pipe at a given temperature is a function of the material strength from which the pipe is made and the geometry of the pipe as defined by its diameter and wall thickness. The following expression, commonly known as the ISO equation, is used in thermoplastic pipe specifications to relate these factors:

$$P = 2S / (D_o/t - 1)$$

where: P = maximum pressure rating, psi
 S = maximum hydraulic design stress (max. working strength), psi
 D_o = average outside pipe diameter, in.
 t = minimum wall thickness, in.

The allowable design stress, which is the tensile stress in the hoop direction of the pipe, is derived for each material in accordance with ASTM D 2837, Standard Test Method for Obtaining Hydrostatic Design Basis for Thermoplastic Pipe Materials, at 73° F. The pressure ratings below were calculated from the basic Hydraulic Design Stress for each of the materials.

Pipe and Fittings

In order to determine the pressure rating for a product system, first find the plastic material and schedule (wall thickness—see Dimensions and References—Schedule 80 components on page 4 for additional information) of pipe and fittings in the heading of the Maximum Non-Shock Operating Pressure table below. Then, locate the selected joining method in the subheading of the table and go down the column to the value across from a particular pipe size, listed in the far left column. This will be the maximum non-shock operating pressure at 73° F for the defined product system.

Maximum Non-Shock Operating Pressure (psi) at 73° F¹

Nom. Pipe Size	Schedule 40		Schedule 80		Schedule 80		Schedule 80	
	PVC & CPVC	PVC & CPVC	Polypropylene	Polypropylene	PVDF	PVDF	PVDF	PVDF
	Socket End	Socket End	Threaded End	Thermo-Seal Joint	Threaded ³ End	Thermo-Seal Joint	Threaded End	
1/2	600	850	420	410	20	580	290	
3/4	480	690	340	330	20	470	230	
1	450	630	320	310	20	430	210	
1 1/4	370	520	260	260	20	—	—	
1 1/2	330	470	240	230	20	326	160	
2	280	400	200	200	20	270	140	
2 1/2	300	420	210	—	—	—	—	
3	260	370	190	190	20	250	N.R.	
4	220	320	160	160	20	220	N.R.	
6	180	280	N.R.	140	N.R.	190	N.R.	
8	160	250 ²	N.R.	—	—	—	—	
10	140	230	N.R.	—	—	—	—	
12	130	230	N.R.	—	—	—	—	

- For more severe service, an additional correction factor may be required.
- 8" CPVC Tee, 90° ELL and 45° ELL rated at 1/2 of value shown. Pressure rating of 175 psi can be obtained by factory overwrapping with glass and polyester. Consult Customer Service for delivery information.
- Recommended for intermittent drainage pressure not exceeding 20 psi. N.R. Not Recommended.

Valves, Unions, and Flanges

The maximum pressure rating for Chemtrol valves, flanges, and unions, regardless of size, is 150 psi at 73° F. As with all other thermoplastic piping components, the maximum non-shock operating pressure is related to temperature. Above 100° F refer to the chart below.

Maximum Non-Shock Operating Pressure (psi) vs. Temperature

Operating Temperature (° F)	PVC	CPVC	PP	PVDF
100	150	150	150	150
110	135	140	140	150
120	110	130	130	150
130	75	120	118	150
140	50	110	105	150
150	N.R.	100	93	140
160	N.R.	90	80	133
170	N.R.	80	70	125
180	N.R.	70	50	115
190	N.R.	60	N.R.	106
200	N.R.	50	N.R.	97
250	N.R.	N.R.	N.R.	50
280	N.R.	N.R.	N.R.	25

N.R. Not Recommended.

Temperature Ratings of Chemtrol Products

Since the strength of plastic pipe is sensitive to temperature, the identical test method is used to determine the material strength at elevated temperature levels. The correction factor for each temperature is the ratio of strength at that temperature level to the basic strength at 73° F. Because the hoop stress is directly proportional to the internal pressure, which created that pipe stress, the correction factors may be used for the temperature correction of pressure as well as stress. For pipe and fitting applications above 73° F, refer to the table below for the Temperature Correction Factors. To determine the maximum non-shock pressure rating at an elevated temperature, simply multiply the base pressure rating obtained from the table in the preceding column by the correction factor from the table below. The allowable pressure will be the same as the base pressure for all temperatures below 73° F.

Temperature Correction Factors

Operating Temperature (° F)	Factors			
	PVC	CPVC	PP	PVDF
70	1.00	1.00	1.00	1.00
80	0.90	0.96	0.97	0.95
90	0.75	0.92	0.91	0.87
100	0.62	0.85	0.85	0.80
110	0.50	0.77	0.80	0.75
115	0.45	0.74	0.77	0.71
120	0.40	0.70	0.75	0.68
125	0.35	0.66	0.71	0.66
130	0.30	0.62	0.68	0.62
140	0.22	0.55	0.65	0.58
150	N.R.	0.47	0.57	0.52
160	N.R.	0.40	0.50	0.49
170	N.R.	0.32	0.26	0.45
180	N.R.	0.25	*	0.42
200	N.R.	0.18	N.R.	0.36
210	N.R.	0.15	N.R.	0.33
240	N.R.	N.R.	N.R.	0.25
280	N.R.	N.R.	N.R.	0.18

* Recommended for intermittent drainage pressure not exceeding 20 psi. N.R. Not Recommended.

Pressure Ratings of Chemtrol Products

Chemtrol Products in Vacuum or Collapse Loading Situations

Thermoplastic pipe is often used in applications where the pressure on the outside of the pipe exceeds the pressure inside. Suction or vacuum lines and buried pipe are examples of this type of service.

As a matter of practical application, gauges indicate the pressure differential above or below atmospheric pressure. However, scientists and engineers frequently express pressure on an absolute scale where zero equals a theoretically perfect vacuum and standard atmospheric pressure equals 14.6959 psia.

Vacuum Conversion Factors: See page 6 for additional head and metric factors.

Solvent cemented or thermo-sealed joints are particularly recommended for vacuum service. In PVC, CPVC, PP, or PVDF vacuum systems, mechanical devices such as valves and transition joints at equipment will generally represent a greater intrusion problem than the thermoplastic piping system will. Experience indicates that PVC vacuum systems can be evacuated to pressures as low as 5 microns with continuous pumping. However, when the system is shut off, the pressure will rise and stabilize around 10,000 microns or approximately 10 mm of Mercury at 73° F.

The following chart lists the allowable collapse loading for plastic pipe at 73° F. It shows how much greater the external pressure may be than the internal pressure. (Thus, a pipe with 100 psi internal pressure can withstand 100 psi more external pressure than a pipe with zero psi internal pressure.) For temperatures other than 73° F, multiply the values in the chart by the correction factors listed in the temperature correction table on the preceding page.

The chart also applies to a vacuum. The external pressure is generally atmospheric pressure, or 0.0 psig, while the internal pressure is normally identified as a vacuum or negative gauge pressure. However, this negative value will never exceed -14.7 psig. Therefore, if the allowable pressure listed in the chart (after temperature correction) is greater than the difference for internal-to-external pressure, the plastic system is viable.

Maximum Collapse Pressure Rating, psi @ 73° F					
Pipe Size	PVC Sch. 40	PVC Sch. 80	CPVC Sch. 80	PP Sch. 80	PVDF Sch. 80
1/2	450	575	575	230	391
3/4	285	499	499	200	339
1	245	469	469	188	319
1 1/4	160	340	340	136	—
1 1/2	120	270	270	108	183
2	75	190	190	76	129
2 1/2	100	220	220	—	—
3	70	155	155	62	105
4	45	115	115	46	78
6	25	80	80	32	54
8	16	50	50	—	—
10	12	43	—	—	—
12	9	39	—	—	—

Pressure Losses in a Piping System

Piping Calculations

As a fluid flows through a piping system, it will experience a head loss depending on, among other factors, fluid velocity, pipe wall smoothness and internal pipe surface area. The Tables on pages 9 and 10 give Friction Loss and Velocity data for Schedule 40 and Schedule 80 thermoplastic pipe based on the Williams and Hazen formula.

$$H = .2083 \left(\frac{100}{C} \right)^{1.852} \times \left(\frac{q}{d^{4.8655}} \right)$$

Where: H = Friction Head Loss in Feet of Water/100 Feet of Pipe
 C = Surface Roughness Constant (150 for all thermoplastic pipe)
 q = Fluid Flow (gallons/min.)
 d = Inside Diameter of Pipe

Fittings and valves, due to their more complex configurations, contribute significant friction losses in a piping system. A common method of expressing the losses experienced in fittings is to relate them to pipe in terms of equivalent pipe length. This is the length of pipe required to give the same friction loss as a fitting of the same size. The Table at the bottom of page 10 is a tabulation of the equivalent pipe length in feet for the various sizes of a number of common fittings. By using this Table and the Friction Loss Tables, the total friction loss in a plastic piping system can be calculated for any fluid velocity.

For example, suppose we wanted to determine the pressure loss across a 2" Schedule 40, 90° elbow, at 75 gpm. From the lower table on page 10 we find the equivalent length of a 2" 90° elbow to be 5.5 feet of pipe. From the Schedule 40 Pipe Table on page 9 we find the friction loss to be 3.87 psi per 100 feet of pipe when the flow rate is 75 gpm. Therefore, the solution is as follows:

$$5.5 \text{ Feet}/90^\circ \text{ Elbow} \times 3.87 \text{ psi}/100 \text{ Feet} = 0.21 \text{ psi Pressure Drop}/90^\circ \text{ Elbow}$$

which is the pressure drop across a 2" Schedule 40 elbow. But, what if it were a 2" Schedule 80 elbow, and we wanted to know the friction head loss? The solution is similar, except we look for the friction head in the Schedule 80 Pipe Table at the top of page 10 and find it to be 12.43 feet per 100 feet of pipe when the flow rate is 75 gpm. The solution follows:

$$5.5 \text{ Feet}/90^\circ \text{ Elbow} \times 12.43 \text{ Feet}/100 \text{ Feet} = 0.68 \text{ Feet Friction Head}/90^\circ \text{ Elbow}$$

which is the friction head loss across a 2" Schedule 80 elbow.

Valve Calculations

As an aid to system design, liquid sizing constants (Cv values) are shown for NIBCO/Chemtrol valves where applicable. These values are defined as the flow rate through the valve required to produce a pressure drop of 1 psi.

To determine the pressure drop for a given condition the following formula may be used:

$$\Delta P = \frac{Q^2 \text{S.G.}}{Cv^2}$$

Where:

- Δ P = Pressure drop across the valve in psi
- Q = Flow through the valve in gpm
- S.G. = Specific gravity of the liquid (Water = 1.0)
- Cv = Flow coefficient

See the solution of the following example problem. For Cv values for specific valves, refer to the product description page in the Chemtrol Thermoplastic Valve Guide.

EXAMPLE:

Find the pressure drop across a 1 1/2" PVC ball check valve with a water flow rate of 50 gpm.

The Cv is 56, as shown in the *Chemtrol Thermoplastic Valve Guide*.

$$\Delta P = \frac{(50)^2 \times 1.0}{(56)^2}$$

$$\Delta P = \left(\frac{50}{56} \right)^2$$

$$\Delta P = .797 \text{ psi}$$

Flow Capacity and Friction Loss for Schedule 40 Thermoplastic Pipe Per 100 Ft.

Gals. Per Minute	1/4" Pipe		3" Pipe		1/2" Pipe		3/4" Pipe		1" Pipe		1 1/4" Pipe		1 1/2" Pipe		2" Pipe		2 1/2" Pipe	
	Velocity (Feet per Second)	Friction Loss (PSI)	Velocity (Feet per Second)	Friction Loss (PSI)	Velocity (Feet per Second)	Friction Loss (PSI)	Velocity (Feet per Second)	Friction Loss (PSI)	Velocity (Feet per Second)	Friction Loss (PSI)	Velocity (Feet per Second)	Friction Loss (PSI)	Velocity (Feet per Second)	Friction Loss (PSI)	Velocity (Feet per Second)	Friction Loss (PSI)	Velocity (Feet per Second)	Friction Loss (PSI)
1/2	1.73	4.90	2.12															
3/4	2.59	10.38	4.50															
1	3.45	17.68	7.66	1.13	1.16	.50	1.26	1.03	.45									
2	6.90	63.82	27.66	2.25	4.19	1.82	3.16	5.60	2.43									
5	17.26	348.29	150.93	5.64	22.88	9.92	4.42	10.44	4.52	1.93	1.69	.73						
7				7.89	42.66	18.49	6.32	20.21	8.76	2.70	3.14	1.36						
10				11.27	82.59	35.79	9.48	42.82	18.56	3.86	6.08	2.63						
15				16.91	175.01	75.84	12.64	72.95	31.61	5.79	12.89	5.59						
20							15.80	110.29	47.80	7.72	21.96	9.52						
25	1.10	.17	.07							9.64	33.20	14.39						
30	1.32	.24	.10							11.57	46.54	20.17						
35	1.54	.32	.14							13.50	61.91	26.83						
40	1.77	.41	.18							15.43	79.28	34.36						
45	1.99	.51	.22	1.02	.11	.05												
50	2.21	.61	.26	1.15	.13	.06												
60	2.85	.86	.37	1.28	.16	.07												
70	3.09	1.15	.50	1.53	.23	.10												
75	3.31	1.30	.56	1.79	.30	.13												
80	3.53	1.47	.64	1.92	.34	.15												
90	3.97	1.82	.79	2.04	.39	.17												
100	4.41	2.22	.96	2.30	.48	.21	1.01	.07	.03									
125	5.52	3.35	1.45	2.56	.59	.26	1.12	.08	.03									
150	6.62	4.70	2.04	3.19	.89	.39	1.40	.12	.05									
175	7.72	6.25	2.71	3.83	1.24	.54	1.68	.17	.07									
200	8.83	8.00	3.47	4.47	1.65	.72	1.97	.22	.10	1.13	.06	.03						
250	11.03	12.10	5.24	5.11	2.12	.92	2.25	.29	.13	1.30	.08	.03						
300	13.24	16.96	7.35	6.39	3.20	1.39	2.81	.43	.19	1.62	.11	.05						
350	15.45	22.56	9.78	7.67	4.49	1.95	3.37	.61	.26	1.94	.16	.07						
400				8.94	5.97	2.59	3.93	.81	.35	2.27	.21	.09						
450				10.22	7.64	3.31	4.49	1.03	.45	2.59	.27	.12						
500				11.50	9.51	4.12	5.05	1.29	.56	2.91	.34	.15						
750				12.78	11.54	5.01	5.61	1.56	.68	3.24	.41	.18						
1000				19.17	24.49	10.61	8.42	3.31	1.43	4.86	.87	.38						
1250							11.23	5.64	2.44	6.48	1.48	.64						
1500							14.04	8.53	3.70	8.09	2.24	.97						
2000							16.84	11.96	5.18	9.71	3.13	1.36						
2500										12.95	5.34	2.31						
3000										16.19	8.07	3.50						
3500																		
4000																		

Flow Capacity and Friction Loss for Schedule 80 Thermoplastic Pipe Per 100 Ft.

Gals. Per Minute	1/4" Pipe	3" Pipe	1/2" Pipe	3/4" Pipe	1" Pipe	1 1/4" Pipe	1 1/2" Pipe	2" Pipe	2 1/2" Pipe	3" Pipe	4" Pipe	6" Pipe	8" Pipe	10" Pipe	12" Pipe
	Velocity (Feet per Second)	Friction Head (Feet)	Friction Loss (PSI)	Velocity (Feet per Second)	Friction Head (Feet)	Friction Loss (PSI)	Velocity (Feet per Second)	Friction Head (Feet)	Friction Loss (PSI)	Velocity (Feet per Second)	Friction Head (Feet)	Friction Loss (PSI)	Velocity (Feet per Second)	Friction Head (Feet)	Friction Loss (PSI)
1/4	1.28	3.57	1.55		1.40	1.04	.45	1.30	.64	.28					
1/2	2.57	12.88	5.58		2.33	9.45	1.16	1.82	1.20	.52					
3/4	3.85	27.29	11.83		3.26	4.98	2.16	2.59	2.32	1.01					
1	5.14	46.49	20.15	.78	4.66	9.65	4.18	3.89	4.91	2.13					
3	15.41	355.60	154.20	2.35	6.99	20.44	8.86	11.67	37.53	16.26					
5				3.92	9.32	34.82	15.09	12.97	45.62	19.77					
7				5.48	11.66	52.64	22.81	15.56	69.94	27.71					
10				7.84	13.99	78.78	31.97	11.25	29.04	12.58					
15				11.75	16.32	98.16	42.54	13.12	38.64	16.74					
20				15.67	18.63	116.62	50.00	14.06	43.90	19.02					
25				19.57	20.92	135.06	58.33	15.00	49.48	21.44					
30				23.47	23.17	153.51	66.66	16.87	61.54	26.67					
35				27.37	25.42	171.96	75.00	18.74	73.60	31.88					
40				31.27	27.67	190.41	83.33	20.61	85.66	37.19					
45				35.17	29.92	208.86	91.67	22.48	97.72	42.50					
50				39.07	32.17	227.31	100.00	24.35	109.78	47.81					
60				48.96	36.42	266.16	120.00	28.24	127.84	56.72					
70				58.85	40.67	305.01	140.00	32.13	145.90	65.63					
75				62.75	42.92	323.46	145.00	33.00	151.80	68.50					
80				66.65	45.17	341.91	150.00	33.87	157.70	71.37					
90				76.54	49.42	380.76	180.00	37.76	183.76	80.28					
100				86.43	53.67	419.61	210.00	41.65	209.81	89.19					
125				105.32	62.52	508.46	255.00	49.54	251.86	107.10					
150				124.21	71.37	597.31	300.00	57.43	293.91	125.01					
175				143.10	80.22	686.16	345.00	65.32	335.96	142.92					
200				162.00	89.07	775.01	390.00	73.21	378.01	160.83					
250				200.89	106.92	952.78	472.50	87.10	455.06	192.74					
300				239.78	124.77	1130.55	555.00	101.00	532.11	224.65					
350				278.67	142.62	1308.32	637.50	114.90	609.16	256.56					
400				317.56	160.47	1486.09	720.00	128.80	686.21	288.47					
450				356.45	178.32	1663.86	802.50	142.70	763.26	320.38					
500				395.34	196.17	1841.63	885.00	156.60	840.31	352.29					
750				523.71	260.23	2418.40	1170.00	204.00	1090.36	460.40					
1000				652.08	324.28	3095.17	1500.00	264.00	1410.41	592.45					
1250				780.45	388.33	3771.94	1800.00	324.00	1730.46	724.50					
1500				908.82	452.38	4448.71	2100.00	384.00	2050.51	856.55					
2000				1171.69	580.51	5731.48	2700.00	504.00	2710.56	1120.60					
2500				1434.56	708.64	7014.25	3300.00	624.00	3370.61	1384.65					
3000				1697.43	836.77	8297.02	3900.00	744.00	4030.66	1648.70					
3500				1960.30	964.90	9579.79	4500.00	864.00	4690.71	1912.75					
4000				2223.17	1093.03	10862.56	5100.00	984.00	5350.76	2176.80					

FRICITION LOSS IN FITTINGS — EQUIVALENT LENGTH OF PIPE, Feet

SIZE FITTING

TYPE FITTING	1/4"	1/2"	3/4"	1"	1 1/4"	1 1/2"	2"	2 1/2"	3"	4"	6"	8"	10"	12"
90° Standard Elbow	0.9	1.6	2.1	2.6	3.5	4.0	5.5	6.2	7.7	10.1	15.2	20.0	25.1	29.8
45° Standard Elbow	0.5	0.8	1.1	1.4	1.8	2.1	2.8	3.3	4.1	5.4	8.1	10.6	13.4	15.9
90° Long Radius Elbow	0.6	1.0	1.4	1.7	2.3	2.7	4.3	5.1	6.3	8.3	12.5	16.5	20.7	24.7
90° Street Elbow	1.5	2.6	3.4	4.4	5.8	6.7	8.6	10.3	12.8	16.8	25.3	33.3	41.8	49.7
45° Street Elbow	0.8	1.3	1.8	2.3	3.0	3.5	4.5	5.4	6.6	8.7	13.1	17.3	21.7	25.9
Square Corner Elbow	1.7	3.0	3.9	5.0	6.5	7.6	9.8	11.7	14.6	19.1	28.8	37.9	47.6	56.7
Standard — with flow thru run	0.6	1.0	1.4	1.7	2.3	2.7	4.3	5.1	6.3	8.3	12.5	16.5	20.7	24.7
Tee — with flow thru branch	1.8	4.0	5.1	6.0	6.9	8.1	12.0	14.3	16.3	22.1	32.2	39.9	50.1	59.7

Hydraulic Shock

Hydraulic shock is the term used to describe the momentary pressure rise in a piping system which results when the liquid is started or stopped quickly. This pressure rise is caused by the momentum of the fluid; therefore, the pressure rise increases with the velocity of the liquid, the length of the system from the fluid source, or with an increase in the speed with which it is started or stopped. Examples of situations where hydraulic shock can occur are valves which are opened or closed quickly or pumps which start with an empty discharge line. Hydraulic shock can even occur if a high-speed wall of liquid (as from a starting pump) hits a sudden change of direction in the piping, such as an elbow.

The pressure rise created by the hydraulic shock effect is added to whatever fluid pressure exists in the piping system and, although only momentary, this shock load can be enough to burst pipe and break fittings or valves.

Proper design when laying out a piping system will limit the possibility of hydraulic shock damage.

The following suggestions will help in avoiding problems:

1. In a plastic piping system, a fluid velocity not exceeding 5 ft./sec. will minimize hydraulic shock effects, even with quickly closing valves, such as solenoid valves. (Flow is normally expressed in GALLONS PER MINUTE—GPM. To determine the fluid velocity in any segment of piping the following formula may be used:)

$$v = \frac{.4085 \text{ GPM}}{D_i^2}$$

Where: v = fluid velocity in feet per second
 D_i = inside diameter
 GPM = rate of flow in gallons per minute

See the Flow Capacity Tables on pages 9 and 10 for the fluid velocities resulting from specific flow rates in Schedule 40 and Schedule 80 pipes. The upper threshold rate of flow for any pipe may be determined by substituting 5 ft./sec. fluid velocity in the above formula and solving for GPM.

$$\text{Upper Threshold Rate of Flow (GPM)} = 12.24 D_i^2$$

See the Pipe Reference Table on page 4 for the Upper Threshold Flow Rate in specific sizes of Schedule 80 Pipes.

2. Using actuated valves, which have a specific closing time, will eliminate the possibility of someone inadvertently slamming a valve open or closed too quickly. With air-to-air and air-to-spring actuators, it will probably be necessary to place a flow control valve in the air line to slow down the valve operation cycle, particularly on valve sizes greater than 1 1/2".
3. If possible, when starting a pump, partially close the valve in the discharge line to minimize the volume of liquid that is rapidly accelerating through the system. Once the pump is up to speed and the line completely full, the valve may be opened.
4. A check valve installed near a pump in the discharge line will keep the line full and help prevent excessive hydraulic shock during pump start-up. Before initial start-up the discharge line should be vented of all air. Air trapped in the piping will substantially reduce the capability of plastic pipe withstanding shock loading.

Shock Surge Wave

Providing all air is removed from an affected system, a formula based on theory may closely predict hydraulic shock effect.

$$p = v \left(\frac{SG - 1}{2} C + C \right)$$

Where: p = maximum surge pressure, psi
 v = fluid velocity in feet per second (see Table on pages 9 and 10 for flow/velocity conversion).
 C = surge wave constant for water at 73° F.
 *SG = specific gravity of liquid

*if SG is 1, then $p = vC$

EXAMPLE:

A 2" PVC Schedule 80 pipe carries a fluid with a specific gravity of 1.2 at a rate of 30 gpm and at a line pressure of 160 psi. What would the surge pressure be if a valve were suddenly closed?

From table below: $c = 24.2$ From upper table on page 10 $v = 3.35$

$$p = 3.35 \left(\frac{(1.2 - 1)}{2} 24.2 + 24.2 \right)$$

$$p = (3.35) (26.6) = 90 \text{ psi}$$

Total line pressure = 90 + 160 = 250 psi

Schedule 80 2" PVC from the chart on page 7 has a pressure rating of 400 psi at room temperature. Therefore, 2" Schedule 80 PVC pipe is acceptable for this application.

Pipe	Surge Wave Constant (C)					
	PVC		CPVC		Polypropylene PVDF	
	Sch. 40	Sch. 80	Sch. 40	Sch. 80	Sch. 80	Sch. 80
1/4	31.3	34.7	33.2	37.3	—	—
3/8	29.3	32.7	31.0	34.7	—	—
1/2	28.7	31.7	30.3	33.7	25.9	28.3
3/4	26.3	29.8	27.8	31.6	23.1	25.2
1	25.7	29.2	27.0	30.7	21.7	24.0
1 1/4	23.2	27.0	24.5	28.6	19.8	—
1 1/2	22.0	25.8	23.2	27.3	18.8	20.6
2	20.2	24.2	21.3	25.3	17.3	19.0
2 1/2	21.1	24.7	22.2	26.0	—	—
3	19.5	23.2	20.6	24.5	16.6	18.3
4	17.8	21.8	18.8	22.9	15.4	17.0
6	15.7	20.2	16.8	21.3	14.2	15.8
8	14.8	18.8	15.8	19.8	—	—
10	14.0	18.3	15.1	19.3	—	—
12	13.7	18.0	14.7	19.2	—	—
14	13.4	17.9	14.4	19.2	—	—

CAUTION: The removal of all air from the system in order for the surge wave analysis method to be valid was pointed out at the beginning of this segment. However, this can be easier said than done. Over reliance on this method of analysis is not encouraged. Our experience suggests that the best approach to assure a successful installation is for the design to focus on strategic placements of air vents and the maintenance of fluid velocity near or below the threshold limit of 5 ft./sec.

Expansion and Thermal Contraction of Plastic Pipe

Calculating Dimensional Change

All materials undergo dimensional change as a result of temperature variation above or below the installation temperature. The extent of expansion or contraction is dependent upon the coefficient of linear expansion for the piping material. These coefficients are listed below for the essential industrial plastic piping materials in the more conventional form of inches of dimensional change, per ° F of temperature change, per inch of length. They are also presented in a more convenient form to use. Namely, the units are inches of dimensional change, per 10° F temperature change, per 100 feet of pipe.

Material	C – in/in/° F x 10 ⁵	Y – in/10° F/100 ft.
PVC	3.0	.360
CPVC	3.8	.456
PP	5.0	.600
PVDF	7.9	.948

The formula for calculating thermally induced dimensional change, utilizing the convenient coefficient (Y), is dependent upon the temperature change to which the system may be exposed – between the installation temperature and the greater differential to maximum or minimum temperature – as well as, the length of pipe run between directional changes or anchors points. Also, a handy chart is presented at the bottom of this column, which approximates the dimensional change based on temperature change vs. pipe length.

$$\Delta L = \frac{Y(T_1 - T_2)}{10} \times \frac{L}{100}$$

- Δ L = Dimensional change due to thermal expansion or contraction (in.)
- Y = Expansion coefficient (See table above)
(in/10°/100 ft)
- (T₁-T₂) = Temperature differential between the installation temperature and the maximum or minimum system temperature, whichever provides the greatest differential (° F).
- L = Length of pipe run between changes in direction (ft.)

EXAMPLE 1:

How much expansion can be expected in a 200 foot straight run of 3 inch PVC pipe that will be installed at 75° F when the piping system will be operated at a maximum of 120° F and a minimum of 40° F?

$$\Delta L = \frac{(120 - 75)}{10} \times \frac{200}{100} = .360 \times 4.50 \times 2.0 = 3.24 \text{ inches}$$

Expansion or Contraction of PVC Pipe (in.)

Temp. Change*	Length of Pipe to Closest Anchor Point (ft.)									
ΔT° F	10'	20'	30'	40'	50'	60'	70'	80'	90'	100'
10°	0.04	0.07	0.11	0.14	0.18	0.22	0.25	0.29	0.32	0.36
20°	0.07	0.14	0.22	0.29	0.36	0.43	0.50	0.58	0.65	0.72
30°	0.11	0.22	0.32	0.43	0.54	0.65	0.76	0.86	0.97	1.08
40°	0.14	0.29	0.43	0.58	0.72	0.86	1.00	1.15	1.30	1.44
50°	0.18	0.36	0.54	0.72	0.90	1.08	1.26	1.44	1.62	1.80
60°	0.22	0.43	0.65	0.86	1.08	1.30	1.51	1.73	1.94	2.16
70°	0.25	0.50	0.76	1.01	1.26	1.51	1.76	2.02	2.27	2.52
80°	0.29	0.58	0.86	1.15	1.44	1.73	2.02	2.30	2.59	2.88
90°	0.32	0.65	0.97	1.30	1.62	1.94	2.27	2.59	2.92	3.24
100°	0.36	0.72	1.08	1.44	1.80	2.16	2.52	2.88	3.24	3.60
110°	0.40	0.79	1.19	1.58	1.98	2.38	2.77	3.17	3.56	3.96
120°	0.43	0.86	1.30	1.73	2.16	2.59	3.02	3.46	3.89	4.32

* Temperature change (ΔT) from installation to the greater of maximum or minimum limits.

To determine the expansion or contraction for pipe of a material other than PVC, multiply the change in length given for PVC in the table above by 1.2667 for the change in CPVC, by 1.6667 for the change in PP, or by 2.6333 for the change in PVDF.

Calculating Stress

If movement resulting from thermal changes is restricted by the piping support system or the equipment to which it is attached, the resultant forces may damage the attached equipment or the pipe itself. Therefore, pipes should always be anchored independently at those attachments. If the piping system is rigidly held or restricted at both ends when no compensation has been made for thermally induced growth or shrinkage of the pipe, the resultant stress can be calculated with the following formula.

$$S_t = EC (T_1 - T_2)$$

S_t = Stress (psi)

E = Modulus of Elasticity (psi) (See table below for specific values at various temperatures)

C = Coefficient of Expansion (in/in/° F x 10⁵) (see physical property chart on page 2 for values)

(T₁-T₂) = Temperature change (° F) between the installation temperature and the maximum or minimum system temperature, whichever provides the greatest differential.

Temperature vs. Modulus (x 10⁵) psi

	73° F	90° F	100° F	140° F	180° F	210° F	250° F
PVC	4.20	3.75	3.60	2.70	N/A	N/A	N/A
CPVC	4.23	4.00	3.85	3.25	2.69	2.20	N/A
PP	1.79	1.25	1.15	.72	.50	N/A	N/A
PVDF	2.19	1.88	1.74	1.32	1.12	.81	.59

N/A - Not Applicable

The magnitude of the resulting longitudinal force can be determined by multiplying the thermally induced stress by the cross sectional area of the plastic pipe.

$$F = S_t \times A$$

F = FORCE (lbs)

S_t = STRESS (psi)

A = CROSS SECTIONAL AREA (in²)

EXAMPLE 2:

What would be the amount of force developed in 2" Schedule 80 PVC pipe with the pipe rigidly held and restricted at both ends? Assume the temperature extremes are from 70° F to 100° F.

$$S_t = EC (T_1 - T_2)$$

$$S_t = EC (100 - 70)$$

$$S_t = (3.60 \times 10^5) \times (3.0 \times 10^{-5}) (30)$$

$$S_t = 324 \text{ psi}$$

The Outside and Inside Diameters of the pipe are used for calculating the Cross Sectional Area (A) as follows: (See the Pipe Reference Table on page 4 for the pipe diameters and cross sectional area for specific sizes of schedule 80 Pipes.)

$$A = \pi/4 (OD^2 - ID^2) = 3.1416/4 (2.375^2 - 1.913^2) = 1.556 \text{ in.}^2$$

The force exerted by the 2" pipe, which has been restrained, is simply the compressive stress multiplied over the cross sectional area of that pipe.

$$F = S_t \times A$$

$$F = 324 \text{ psi} \times 1.556 \text{ in.}^2$$

$$F = 504 \text{ lbs.}$$

Managing Expansion/Contraction in System Design

Stresses and forces which result from thermal expansion and contraction can be reduced or eliminated by providing for flexibility in the piping system through frequent changes in direction or introduction of loops as graphically depicted on this page.

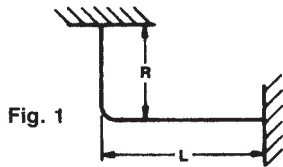

Normally, piping systems are designed with sufficient directional changes, which provide inherent flexibility, to compensate for expansion and contraction. To determine if adequate flexibility exists in leg (R) (see Fig. 1) to accommodate the expected expansion and contraction in the adjacent leg (L) use the following formula:

$$R = 2.877\sqrt{D \Delta L} \text{ SINGLE OFFSET FORMULA}$$

Where: R = Length of opposite leg to be flexed (ft.)
D = Actual outside diameter of pipe (in.)
 ΔL = Dimensional change in adjacent leg due to thermal expansion or contraction (in.)

Keep in mind the fact that both pipe legs will expand and contract. Therefore, the shortest leg must be selected for the adequacy test when analyzing inherent flexibility in naturally occurring offsets.

EXAMPLE 3:

What would the minimum length of a right angle leg need to be in order to compensate for the expansion if it were located at the unanchored end of the 200 ft. run of pipe in Example 1 from the previous page?

$$R = 2.877\sqrt{3.500 \times 3.24} = 9.69 \text{ ft.}$$

Flexibility must be designed into a piping system, through the introduction of flexural offsets, in the following situations:

1. Where straight runs of pipe are long.
2. Where the ends of a straight run are restricted from movement.
3. Where the system is restrained at branches and/or turns.

Several examples of methods for providing flexibility in these situations are graphically presented below. In each case, rigid supports or restraints should not be placed on a flexible leg of an expansion loop, offset or bend.

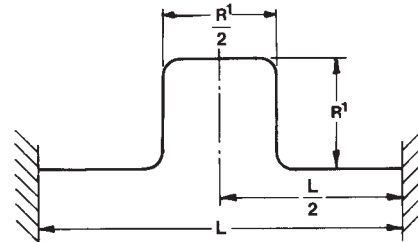
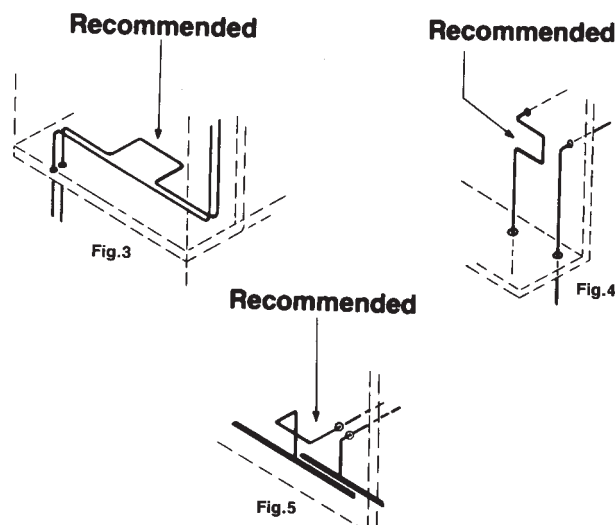

An expansion loop (which is fabricated with 90° elbows and straight pipe as depicted in Fig. 2) is simply a double offset designed into an otherwise straight run of pipe. The length for each of the two loop legs (R'), required to accommodate the expected expansion and contraction in the pipe run (L), may be determined by modification of the SINGLE OFFSET FORMULA to produce a LOOP FORMULA, as shown below:

$$R' = 2.041\sqrt{D \Delta L} \text{ LOOP FORMULA}$$

EXAMPLE 4:

How long should the expansion loop legs be in order to compensate for the expansion in Example 1 from the previous page?

$$R' = 2.041\sqrt{3.500 \times 3.24} = 6.87 \text{ ft.}$$

Minimum Cold Bending Radius

The formulae above for Single Offset and Loop bends of pipe, which are designed to accommodate expansion or contraction in the pipe, are derived from the fundamental equation for a cantilevered beam – in this case a pipe fixed at one end. A formula can be derived from the same equation for calculating the minimum cold bending radius for any thermoplastic pipe diameter.

Minimum Cold Bend Radius

$$R_b = D_o (0.6999 E/S_b - 0.5)$$

Where: R_b = Minimum Cold Bend Radius (in.)
 D_o = Outside Pipe Diameter (in.)
 E^* = Modulus of Elasticity @ Maximum Operating Temperature (psi)
 S_b^* = Maximum Allowable Bending Stress @ Maximum Operating Temperature (psi)

*The three formulae on this page provide for the maximum bend in pipe while the pipe operates at maximum long-term internal pressure, creating maximum allowable hydrostatic design stress (tensile stress in the hoop direction). Accordingly, the maximum allowable bending stress will be one-half the basic hydraulic design stress at 73° F with correction to the maximum operating temperature. See the table at the top of the second column on page 7. The modulus of elasticity, corrected for temperature may be found in the table in the second column of the preceding page.

EXAMPLE 5:

What would be the minimum cold radius bend, which the installer could place at the anchored end of the 200 ft. straight run of pipe in Examples 1 and 3, when the maximum operating temperature is 100° F instead of 140°?

$$R_b = 3.500 (0.6999 \times 360,000 / 1/2 \times 2000 \times 0.62 - 0.5) = 1,420.8 \text{ inches or } 118.4 \text{ feet}$$

PIPE SUPPORT SPACING

Correct supporting of a piping system is essential to prevent excessive bending stress and to limit pipe "sag" to an acceptable amount. Horizontal pipe should be supported on uniform centers, which are determined for pipe size, schedule, temperature, loading and material.

Point support must not be used for thermoplastic piping and, in general, the wider the bearing surface of the support the better. Supports should not be clamped in such a way that will restrain the axial movement of pipe that will normally occur due to thermal expansion and contraction. Concentrated loads in a piping system, such as valves must be separately supported.

The graphs on this page give recommended support spacing for Chemtrol thermoplastic piping materials at various temperatures. The data is based on fluids with a specific gravity of 1.0 and permits a sag of less than 0.1" between supports. For heavier fluids, the support spacing from the graphs should be multiplied by the correct factor in the table below.

Specific Gravity

1.0	1.1	1.2	1.4	1.6	2.0	2.5
1.0	.98	.96	.93	.90	.85	.80

Correction Factor

PVC Schedule 40

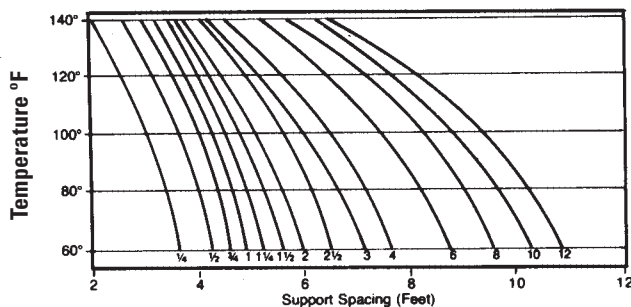

PVC Schedule 80

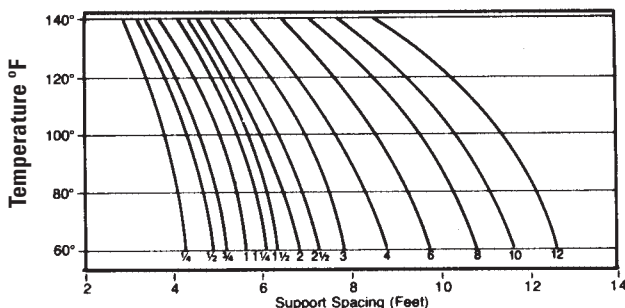

CPVC Schedule 80

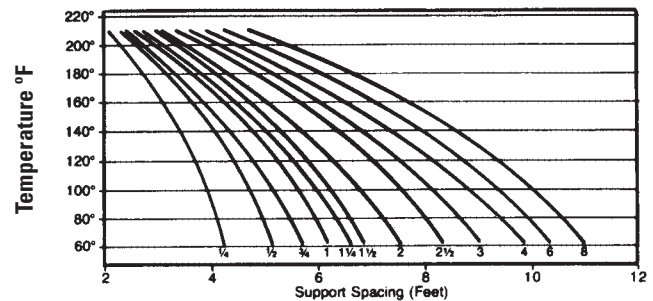

Polypropylene Schedule 80

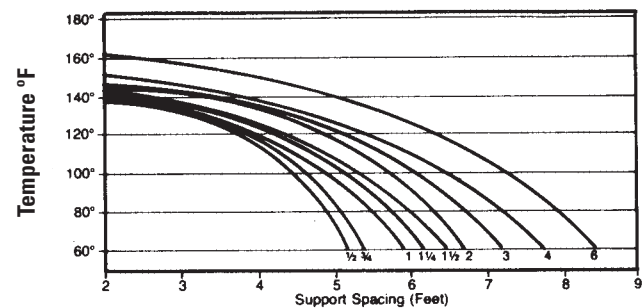

PVDF (KYNAR®) Schedule 80

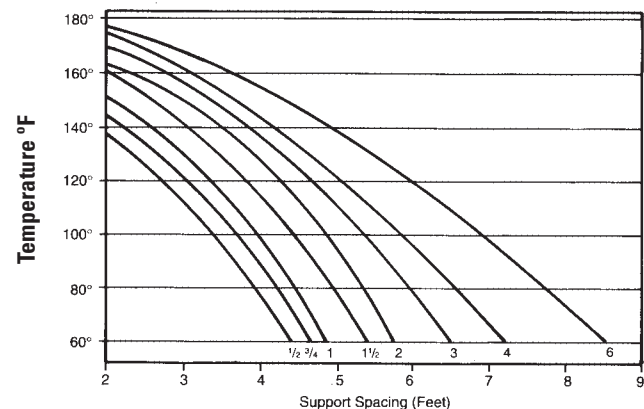

The above data is for uninsulated lines. For insulated lines, reduce spans to 70% of graph values. For spans of less than 2 feet, continuous support should be used.

Storage, Handling, Joining Methods and Preparation for Joining Industrial Thermoplastic Pressure Piping

Storage

Industrial thermoplastic piping components are designed and manufactured for use in systems for severe duty involving the transport of aggressive liquids. In order to ensure their integrity once installed, they must be handled with reasonable care prior to installation.

Pipe

When pipe is received in standard lifts it should remain in the lift until ready for use. Lifts should not be stacked more than eight feet high and should always be stacked wood on wood. Loose pipe should be stored on racks with a minimum support spacing of three to eight feet, depending on size. Pipe should be shaded but not covered directly when stored outside in high ambient temperature. This will provide for free circulation of air and reduce the heat build-up due to direct sunlight exposure.

Fittings and Valves

Fittings and valves should be stored in their original cartons to keep them free of dirt and reduce the potential for damage. If possible, fittings and valves should be stored indoors.

Solvent Cement and Primer

Solvent cement has a definite shelf life and each can and carton is clearly marked with a date of manufacture. Stock should be rotated to ensure that the oldest material is used first. Primer does not have a shelf life, but it is a good practice to rotate this stock also. Solvent cement and primer should be stored in a relatively cool shelter away from direct sun exposure.

CAUTION: Solvent cement and primer are composed of volatile solvents and require special conditions for storage. Because of the flammability, they must not be stored in an area where they might be exposed to ignition, heat, sparks or open flame.

Handling

Pipe, Fittings and Valves

Care should be exercised to avoid rough handling of thermoplastic piping appurtenances. They should not be dragged over sharp projections, dropped or have objects dropped upon them. Before use, pipe ends should be inspected for cracks resulting from such abuse. Whether pipe is transported by closed truck or open trailer, the plane of support must be level and continuous under the wood frames of lifts or bundles of loose pipe and all sharp edges of the truck bed, which may come in contact with the pipe must be padded.

Solvent Cement and Primer

Keep shipping containers of solvent cement and primer tightly closed except when transferring product to applicator containers, and keep a lid – even a piece of flat cardboard – on applicator containers when not in use. After each joint, wipe the respective cement and primer applicator brushes free of excess material on the top inside edge of the applicator containers and temporarily store the applicators in a container of high boiling solvent, such as MEK cleaner. This temporary brush storage container will not require a lid. Avoid prolonged breathing of solvent vapor, and when joints are being made in partially enclosed areas use a ventilating device to attenuate vapor levels. Keep solvent cement, primer and cleaners away from all sources of ignition, heat, sparks and open flames. Avoid repeated contact of the solvents with skin. Application of the cement or primer with rags and bare hands must be severely discouraged. Stiff olefin or polyester crimped-bristle brushes and other suitable applicators are safer and more effective.

DANGER: Extremely flammable. Vapor harmful. May be harmful if swallowed. Direct contact causes eye irritation and may cause skin irritation. Keep away from heat, sparks and open flame. Use only with adequate ventilation. FIRST AID: In case of skin contact, flush with water; for eyes, flush with water for at least 15 minutes and seek medical attention. Wash contaminated clothing before reuse. If swallowed, DO NOT INDUCE VOMITING, call physician immediately.

Joining Methods for Pressure Piping

One of the more important features of industrial thermoplastics is the ease with which they lend themselves to a variety of fabricating techniques, a marked contrast with high alloy metallic or reinforced thermoset plastic

piping. This versatility, plus the wide selection of components and materials, makes fast and economical installation, maintenance and modification of industrial piping systems a reality.

Detailed step-by-step installation instructions are given in this section for joint preparation, solvent cementing and thermo-fusion of socket joints. These techniques are unique to thermoplastic piping. However, on-site training for design and contract administration engineers and installation mechanics is available from the network of Chemtrol Technical Service or Sales Engineers and approved Distributor Sales personnel. General instruction and comments are also presented in this section for the installation of thread, flange and union joints. These techniques are essentially borrowed from metal piping, so the basic training and job experience for installation mechanics should have included these subjects. As with all other mechanical construction, the contractual requirement for installer training is the province of the design engineer, while the quality control of installation workmanship is the province of the contract administrator.

Socket Fusion

Whenever possible the designer should choose socket fusion joining with flange or union assembly points. Whether solvent welding or thermo-sealing joints (material dependent), socket fusion is the most economical, as well as the most reliable, method for joining thermoplastic piping. Both joining processes are easy to master. So, after more than a 40 years existence for both, nothing less than consistent and manufacturer-proven joining techniques should be acceptable. The degree of reliability and cost associated with rework is solely a function of training and demonstrated technique by the installation mechanic.

Solvent Weld

The chemical fusion of pipe into a socket fitting is made possible by partial dissolution of the surface materials on pipe and the socket connector with a solvent primer followed by applications of solvent cement to those surfaces before pushing the joint together. Since the solvent cement contains dissolved parent material, there is a commingling of pipe, cement and fitting materials as the joint is made and twisted 90°, such that upon evaporation of the volatile solvents a single residual material is chemically bonded or fused. Traditional cement, or glue, i.e. foreign material carried in an organic solvent or water base and acting as an alien interface for bonding two surfaces together, has not been used for making thermoplastic piping joints. Solvent welding is an easy and inexpensive joining method for pipe. However, in order to be a candidate for this method, the piping material itself must be soluble in relatively volatile organic solvent(s). PVC, CPVC and ABS are such materials commonly used for commercial and industrial piping applications.

Thermo-Fusion (Heat Fusion)

The heat fusion of pipe into a socket fitting is made possible by partial melting of the surface materials on pipe and the socket connector with electrically heated female and male anvils, respectively, applied to those surfaces before pushing the joint together. Since the heated anvils are designed to diametrically interfere with the pipe and socket in matching geometric cones; and the plastic melt swells when passing through the phase change from solid material; there is a commingling of pipe and fitting materials as the joint is stabbed together. Upon cooling a single material is solidly fused. There is a similar joining method called butt fusion where pipe-to-pipe or pipe-to-fitting-face joints are made by partial melting the ends to be joined by holding them against an electrically heated plate, and then pushing the butt ends together. However, because of problems associated with longitudinal alignment, uneven cooling and differential melt pressure during cooling, butt fusion joining should never be used for conveying hazardous liquids, particularly above ground. These joints have been known to shatter without warning too frequently for industrial chemical usage. Butt fusion is an ideal joining method for under ground low-pressure gas piping and high-purity process water systems.

Polypropylene (PP) and PVDF (Kynar[®]) can not be dissolved by even the strongest of organic solvents. Therefore, it is not possible to join these materials by solvent cementing. But PP and PVDF lend themselves to being

joined using the socket heat fusion technique. For these fitting and valve product lines Chemtrol offers two different sizes of kits with hand-held heat tools applicable for pipe sizes through 4". Three different sizes of machines with self-contained heat tools applicable for pipe sizes through 6" offer perfect joint penetration depth and longitudinal alignment. PVC and CPVC are not candidates for the heat fusion joining method because they rapidly decompose and out-gas at the process temperature required to melt them. Hence, inadequate joint strength can be developed.

Thread (Tapered National Pipe Threads)

Threaded joints are sometimes used for emergency repairs and when a piping system must be dismantled for occasional cleaning or modifications. Since threading results in a reduction in the effective wall thickness of the pipe, the pressure rating of threaded pipe is reduced to one-half that of unthreaded pipe, i.e. pipe joined by solvent cementing or heat fusion. Because of the serious strength reduction, only Sch. 80 or greater wall thickness of plastic pipe is recommended for threading – never Sch. 40. Threaded joints are not a realistic method for material transition at vessels, equipment and pumps because external mechanical stresses are concentrated at the notch sensitive plastic thread – metals are typically stronger than plastic by five or more orders of magnitude. A great difference in the thermal coefficients of expansion, between the materials to be joined, makes the threaded joint more susceptible to leakage. In spite of recommendation to the contrary, if a metal-to-plastic threaded joint is to be made, the plastic component shall be the male thread member. If it leaks, the tendency is to tighten the thread, and if plastic is the female member, it can easily be split from over-tightening. See the union joint below for the proper solution for material transition. Threaded systems are not recommended for pressure piping, because of Polypropylene's extremely low modulus of elasticity (the joints will leak in time).

Other Mechanical Joints

Flange

Flanges are an old method of joining, but they continue to be used extensively on vessels, equipment and pumps. Particularly in sizes above 3", flanges are the easiest way to disassemble piping for cleaning and modification or maintenance of equipment, so joining method and location within the system are important factors in planning for maintenance efficiency. Socket fittings and valves are flanged with plain-end short nipples by solvent welding or heat fusing (depending on material type) both joints. Flanges are similarly joined to straight pipe runs, or they can be threaded.

Pipe Union

Particularly in sizes 3" and below, unions are the easiest and most reliable way to disassemble piping for cleaning and modification or maintenance of equipment. They are, unfortunately, too often overlooked in planning the design of thermoplastic piping systems. The factors that make threaded joints unrealistic as a method for transition between materials are given in the paragraph above discussing threads. These reasons catalyzed Chemtrol's development of: True Union Valves; Pipe Union with end connectors and union nuts that are interchangeable with the True Union Valve; and stainless steel or brass transition end connectors that are interchangeable with plastic end connectors for both the Pipe Unions and True Union Valves. So, transition end connectors may be affixed to equipment presenting male or female threads, or tank adapters may be used to replace tank connections designed to present threads. As with flanges, we urge the designer to plan the placement of pipe unions in order to enhance maintenance and modification efficiency.

Preparation of Pipe and Fittings & Valves for All Joining Methods

Before starting any type of joining method the first step is to always inspect the pipe and fitting or valve for any flaws, such as deep scratches or gouges, excessive warping or broken pipe ends. If there is any doubt about the soundness of the materials, it is always better to be on the safe side and discard a potentially defective pipe or fitting than to install it and have to repair it later. Regardless of which joining method is to be employed –

thread, socket fusion [chemical fusion (solvent cement)] or thermo-sealing (heat fusion), grooved end (pioneered by Victaulic Co. of America) or integral bell gasketed joints (water and sewer piping) – the preparation for jointing is identical. The method will be presented below and referenced in each set of installation instructions for specific joining methods that follow.

Cleaning

Surfaces to be joined must be free of dirt and dust, grease, paint splashes, water or other substances. If clean surfaces can not be achieved with a dry paper or cotton towel or rag, try a solvent such as Methyl Ethyl Ketone (MEK), available as a cleaner from many distributors of industrial plastic piping, or Isopropyl Alcohol. Use a light emery cloth for removal of paint splatters. If reasonable attention has been given to storage and handling of the products, a light dusting is all that will be required. Open all valves and/or remove end connectors from union ends prior to joining in order to provide ventilation and help prevent chemical or heat distortion of sealing surfaces during joining.

Pipe Cutting

The objective is to cut the pipe squarely so that it can be evenly chamfered on the outside edge. These steps are essential to enable a good joint fit between pipe and fitting and to optimize the ease of making the joint, particularly if the pipe is to be threaded or socket fused. The smaller sizes of plastic pipe can easily be cut with a pipe or tubing cutter, which has a cutting wheel that is specifically designed for plastic. Such a cutter is made by several manufacturers and supplied by mechanical distributors. Chemtrol supplies three different cutting tools for the range of pipe sizes through 6". Rigid Tool Div., T. D Williamson Co., Tulsa, OK, makes them. These same manufacturers also make wheel cutters for pipe through the 12" size. Palm gripped shear cutters, commonly used for thin-wall plastic condensate, irrigation or utility service pipe or tubing, are unacceptable for thick-wall industrial piping.



The pipe can also be cut with a power or hand saw provided the blade is guided to make a perfectly square cut. For example, "trying" to cut the pipe squarely, while holding it with one hand and operating a skill saw with the other, is unacceptable. Use a miter box for a hand saw or a guide rail for a table saw or a hold-down jig for a band saw. For best results use a fine-toothed blade (16-18 teeth per inch). And, if a large quantity of pipe is to be cut, use carbide-tipped blades.

Deburring and Beveling

All pipe ends should be beveled to approximately the dimensions shown below for easier installation, better fit and proper joint. There are several manufacturers of beveling tools specifically for plastic which are sold by mechanical distributors who provide plastic piping through 12" size. Chemtrol supplies two different beveling tools: a small one for pipe sizes through 4" and a large one for pipe sizes 1/2" – 8" manufactured by Reed Manufacturing Co., Erie, PA. Although it takes much longer to do an adequately neat job, the pipe can be beveled with a coarse file. Then each cut pipe end should be deburred on the ID. Use a deburring tool, knife or a half-round coarse file to remove all burrs, chips, filings, etc., including any that may be left on the OD. To complete the pipe end, it may be necessary to wipe the surface and inside of the pipe again. Now the installer is ready to proceed with the selected joining method.

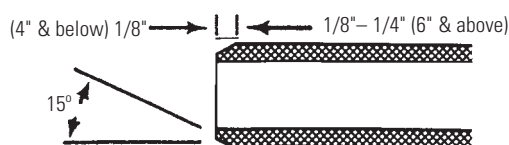

Solvent Cement Joining for PVC & CPVC Pressure Piping Systems

Materials and Tools

Selection of Solvent Cement and Purple Primer

There are a variety of primers, solvent cleaners and solvent cements manufactured, but most are for the less demanding low-pressure water, drainage or conduit applications of piping. However, for the more demanding industrial pressure piping applications, PVC and CPVC each require its own solvent cement. These are dark gray and light gray, matching the respective colors of the Sch. 80 piping materials. Both are defined as heavy-bodied cements, containing more than 10% PVC resin, by weight. We recommend that the primer, used for both PVC and CPVC joining, contain a purple dye and that it have the capability of dissolving 10% PVC resin, by weight, as defined by ASTM Standard F 656.

All CPVC solvent cement formulations manufactured, except one, contain small amounts of Fumed Silica, which acts as a thickening agent to keep the cement from flowing off applied surfaces. B. F. Goodrich, manufacturer of Corzan[®] brand CPVC material, and IPS Corp., manufacturer of Weld-On brand solvent cement products, have correlated slowly developing (one to two years) seep leakage from joints in concentrated Bleach service (15% Sodium Hypochlorite + 1½% Sodium Hydroxide) with usage of cement containing the Fumed Silica. They also found that Bleach, other high alkalinity solutions and Hydrofluoric Acid dissolves Fumed Silica. Therefore, for the aforementioned services, we recommend the only known CPVC cement product without Fumed Silica, Weld-On 724, made by IPS Corp., Compton, CA, and formulated especially for industrial applications. In fact, we know of no CPVC applications, for which Weld-On 724 would not be applicable. If PVC piping is to be used in the aforementioned services, we recommend the only currently known PVC cement without Fumed Silica, Oatey Industrial Grade Low VOC Heavy Duty Gray, made by Oatey Corp., Cleveland, OH. Again, we know of no PVC applications, for which this Oatey product would not be applicable.

Deep penetration of adhesion over 80%, or more, of joint surface areas will provide the desired bond strength and leak prevention in a joint. Leakage becomes problematical when less than 50% of joint surface areas exhibit adhesion, and/or when there is a break or absence of hardened cement bead trapped between the pipe chamfer and the ledge at the bottom of the socket. Joint strength will be jeopardized by the combination of shallow penetration and minimal adhesion area. These characteristics may be subjectively observed by sawing the joint in half longitudinally and then forcibly prying the pipe halves from the fitting socket shells. In this regard, the specifying engineer's insistence on use of purple primer will be useful to the piping mechanic as an indicator of surface area covered. It is also a valuable failure analysis tool because the indelible dye may be observed in the substrate of adequately primed joint surfaces.

Selection of Applicators for Primer and Cement

Daubers are frequently attached to the screw-top lids of both purple primer and solvent cement. In such cases we recommend cutting the dauber from the lid with wire pliers and discarding it when the container is first opened. It is essential to work the solvent into the joint surfaces to achieve partial dissolution and swelling. Unfortunately the strength of the dauber handles is inadequate for this purpose. Although the dauber may be used for application of solvent cement to pipe through 2" in size, we find that it is only practical to use them in pint cans for very small jobs done on an infrequent basis because they clump-up with partly dried cement. A stiff olefin or polyester crimped-bristle paintbrush, having a width approximately one-half the actual diameter of the pipe to be joined, is recommended for the proper application of purple primer. This type of brush also works well for spreading solvent cement on joint surfaces.

Job-site Management of Solvent Cement and Primer

The solvents in these products are volatile, so the objective is to minimize evaporation and maintain freshness. There is a shelf date on solvent cement, but not on purple primer. The shelf life is more directed at forcing inventories of products to be rotated because solvent, unlike the plastic products, will not last forever. As a result, the occasions of finding unopened product, which has become defective in the can, are seldom. However, it is easy for the installer to discern defective cement. A spatula or screwdriver should evenly stir the product with no sense of separation of solvent from solids when inserted the full depth of the container. And when the implement is lifted from the cement the product should smoothly flow from it as thoroughly mixed paint or rich cream would, with no signs of gelling, lumps or stringiness. Do not attempt to thin out sluggish cement with thinner or primer. Throw it away.

Product freshness and the avoidance of product wastage can best be managed for installations larger than a simple repair of small diameter piping by transferring purple primer and solvent cement from their shipping container to applicator containers. The shipping container should be kept tightly closed except when transferring product. A coffee can, which will accommodate brush widths up to 3", is acceptable, but polyethylene (PE) plastic works best for applicator containers. Every shape, form and description of PE container, with lids, may be found in a Kmart or Wal-Mart type of store. We have even seen a two-liter soft drink plastic bottle, evenly sheared off in the middle with a flat piece of cardboard as a top, used successfully.



Obviously, a third container, filled to a level greater than the length of brush bristles with MEK solvent cleaner, will be required for the storage of both applicator brushes between joints in order to keep them pliable and free of contaminated dried material. Following the applications of purple primer and solvent cement to a joint, both sides of the brushes should be wiped free of excess material on the top inside edge of the respective applicator containers and the brushes returned to their storage container. Except when using the products, keep lids on the applicator containers. Clean the brushes in the same way on the storage container when ready to dip them in the product applicator containers for the next joint. And when reloading the brushes with product, dip them no deeper than the bristle length to avoid dried material on the crimped metal. As the workday is completed, transfer the unused products to their respective shipping containers and close their tops tightly again. Leave the top off the applicator containers and allow them to dry overnight. The dried film can easily be peeled away from PE the next morning to provide a clean container for another day's work.

If overnight storage of materials and tools is inside, it is not necessary to do more than throw a shop towel across the tops of the brush handles in their storage container to keep contaminants out and further suppress the slow evaporation rate of MEK. If storage is outside, a plastic baggie could be placed over the tops of the brush handles and secured with a rubber band around the container top. For longer-term storage or movement between jobs, brushes may be hung on a homemade frame in a one-gallon paint can. The frame is coat hanger wire bent into a circle to go around the inside bottom of the can with a riser up the side and then bent to make a horizontal cross-member. The frame can be lifted up from the can by the horizontal cross-member and brushes slid on or off the horizontal piece to hang by the eye in the handle. The frame is lowered into the can and the top is pressed on. This arrangement has the added benefit of preventing the brushes from mushrooming due to the long-term support of their own weight on the bottom of the can. For now they will hang freely from the bottom. The brushes will stay pliable indefinitely if the level of MEK solvent covers the bristles.

Tools and Equipment

- Cutting Tool (see Preparation for Joining, pg. 16)
- Beveling Tool (see Preparation for Joining, pg. 16)
- Paper Toweling or Cotton rags (see Preparation for Joining, pg. 16)
- Solvent Cement and Purple Primer Application Brushes (see Selection of... pg. 17)
- Heavy-Bodied Gray Solvent Cement (see Selection of Cement and..., pg. 17)
- Industrial Purple Primer for PVC or CPVC (see Selection of... and Primer, pg. 17)
- Cement and Primer Applicator Containers (see Job-Site Management... pg. 17)
- Job Storage Container for Brushes (see Job-Site Management... pg. 17)
- Come-Along Pipe Joining Tool (following end of 6-Step Application Techniques)
- Pipe Vise (pipe sizes larger than 2")
- Deburring Tool (see Preparation for Joining, pg. 16)
- Pipe Cleaning solvent (see Preparation for Joining, pg. 16)
- Notched Boards (pipe sizes 2" or less)
- Tool Tray (transport materials and tool from joint to joint)

Six Step Application Techniques

Components should be wiped clean, pipe squarely cut, deburred and beveled according to the preparation instructions on page 16. Since the solvents in the cement and primer will absorb water, but water is deleterious to the joining process, the joint surfaces must be dry at the time of joining.

Primer Application

1. Using a stiff olefin or polyester crimped-bristle brush, apply purple primer to the fitting and pipe-end in a 3-step process alternating from fitting to pipe. Apply primer to the fitting freely. Wet the sub-strate of the socket surface by maintaining a rapid and vigorous scouring motion of the applicator over the entire inner socket for five to fifteen seconds. Re-dip the applicator and continue as necessary, but avoid puddling inside the fitting beyond the socket.



2. Apply purple primer to the outer pipe-end surface with the same vigorous scouring motion of the brush, re-dipping the applicator every five to fifteen seconds as necessary. Make sure that the evenly primed length of pipe is at least equal to the fitting socket depth. Quickness is of the essence in order to scrub primer into the surfaces and attain moistened substrata. Note that the pipe-end can be cradled and rotated on a notched block of wood, if working alone, to make application easier and to keep the surface clean.

3. Re-apply primer to the fitting socket in the same manner. When a continuous peel of a few thousandths of an inch thickness can be scraped from the primed surface with an edge, such as a knife blade, the substrate has been adequately primed for a joint. With practice one will learn to observe a slight tackiness and swell in the surfaces when priming is adequate. Alternate applications of the primer always start with the female component. Cementing should not begin until priming is adequate.



Solvent Cement Application

4. Before the primer dries, continue the alternating surface approach by applying solvent cement to the pipe and fitting in a 3-step process. Use a second plastic crimped-bristle brush to spread a continuous film of cement on the outer pipe-end surface for a length at least equal to that of the fitting socket depth. The cement film should be such that it does not run as a sheet and drool from the exterior or into the pipe interior. And the film thickness need be only thick enough to trap the continuing penetration of solvent into the pipe substrate.



5. While the moistened substrate of the fitting socket is still soft and swollen from priming, quickly spread a continuous film of solvent cement onto the entire socket surface. Avoid puddling and run-off of the cement anywhere in the fitting, or beyond the socket depth in belled-end pipe. The cement film need be only thick enough to trap the continuing penetration of solvent into the substrate and to provide an immediate and continuous wet file around the pipe chamfer during its eminent insertion into the fitting socket. Most of this cement will be pushed ahead by the pipe throughout its insertion to the full depth of the socket. A final excess of cement at the bottom of the socket should be avoided because it cannot be removed. Large puddles formed inside the pipe and/or fitting bore serve to dramatically extend the drying time of these solvent affected areas, which translates to reduced strength of the parent material until drying does occur. Mounds of dried cement may also ultimately act as blockages to fluid flow, resulting in unacceptable pressure loss.



6. Put a second coat of solvent cement on the pipe-end. This completes the six steps of alternate surface application for a joint – three of primer and three of cement – starting with the female component. Cement layers on the pipe must be without voids and sufficient to provide an immediate and continuous wet file around the socket entrance radius/chamfer during the eminent insertion of pipe into the fitting socket. Excess cement will be pushed off the pipe throughout its insertion to the full depth of the fitting socket. However, it is critical that the two wet beads – an inside one around the pipe chamfer and an outside one around the socket chamfer – be maintained to form vacuum seals while joining. Although much of the cement will be scraped off both the pipe and socket during joint insertion, some must be redrawn, by vacuum, to back-fill the diametrical gap between pipe and fitting socket. Air will back-fill the joint if either of the wet bead dynamic seals is broken during joint insertion, resulting in a loss of bonding area.



Crew Size

Obviously, the 6-step application method has a joining crew size of one in mind. When the crew size is increased to two, the 6-step principals must be modified such that each crewmember has their own set of primer and cement brushes and each would attend to the application of both solutions to a single joint surface. The total time to prime and spread cement to each surface is essentially the same when the 6-step concept is mimicked by a crew of two. A crew of two should be strongly considered for pipe sizes 2" through 4" and should be mandatory for larger sizes. A come-along type pipe-joining tool, similar to that manufactured by Reed Manufacturing, Erie, PA, is required for the 10" and larger sizes



Joining Pipe Insertion

Immediately upon finishing the application of cement, and before it begins to dry, the pipe must be inserted squarely into the fitting socket. Too much time has elapsed if either of the surface films has dried to the point that the film folds in the socket chamfer upon pipe insertion, rather than forming a wet bead at that location. Rotation of the pipe ¼ turn in the socket, following pipe insertion to the full socket depth, completes the joint. This encourages complete distribution of the cement and its commingling with joint surfaces. In addition to a crew size of two being mandatory for 6" and larger pipe, rotation of the pipe in the fitting may be omitted for these sizes.



After completing the joint it must be held together for a brief time while the cement begins to dry. This is to prevent the pipe from squirting back out of the fitting socket. The phenomena occurs because fresh cement is an excellent lubricant and product standards dictate the socket to be tapered, with the minimum entrance diameter equaling the maximum pipe diameter and the diameter at the bottom of the socket creating a statistical interference with the pipe diameter. Therefore, the joint must be held together for a minimum of 10 to 15 seconds – a little longer for larger sizes. For pipe sizes 6" and larger the holding time may be one to three minutes. If any pipe back-out does occur, the potential for joint failure/leakage is unacceptably great.

Excess Cement

Wipe off all excess cement from the circumference of the pipe and fitting immediately after the joint holding period and before the cement begins to harden. The localized quantity of cement will affect solvent evaporation by extending the drying time of the pipe. Then, gently place the joint onto a level surface to complete the hardening stage before further handling.

Joint Drying Time Guidelines

In the foregoing we have strongly suggested that PVC and CPVC chemical fusion joint integrity depends upon the installation mechanic following Chemtrol's specific handling, storage, inspection, component preparation, bonding materials selection, job-site management of materials, tools usage, application techniques and joining recommendations. Although Chemtrol does not currently manufacture solvent cementing products, the credentials for these recommendations were derived from its pioneering role in the engineering development of these solvent products throughout the initial 42 years of their usage with industrial socket fittings and valves. Joint integrity also greatly depends upon an infinitely wide and uncontrollable set of product and environmental conditions that relate to the determination of joint drying times prior to handling, testing at low or high pressure or exposure to fulltime working pressure. These conditions include size and surface temperature of the joint, specific diametrical fit of joint components and relative humidity. Drying times will be slowed with larger pipe, lower surface temperature, greater clearance fit (product standards contain allowable diametrical tolerances) and higher humidity. Drying times will be become faster as these conditions are reversed.

Because of the variety of these unpredictable conditions that may exist from job to job, Chemtrol can only offer the following general recommendations relative to PVC and CPVC joint drying times:

1. It is best if the actual joining is done in atmospheric temperature above 35/40° F and below 90° F when the joint components are exposed to direct sun.
2. It is best if all joints can have 72 hours of drying time elapse for all sizes of pipe and drying temperatures before the joint is subjected to any appreciable pressure on a fulltime basis.

The installation manager must assume the risk of deciding when PVC or CPVC joints are sufficiently dry for movement or handling, initiating low pressure testing, applying high pressure testing and/or subjecting the new system to the maximum allowable fulltime working pressure. Chemtrol offers the following drying times as a guide in aiding the installer, engineer, owner or other interested parties in making these decisions. The drying times are based on a combination of past field experience and laboratory tests.

Handling

During the initial hardening of the cement, which begins about two minutes after its application (on small sizes), be careful not to move or disturb the joint less the bond of fragile material be broken. A guide for drying times prior to handling a joint appears below.

PVC and CPVC Joint Movement Times

Nominal Pipe Size	Hot Weather*	Mild Weather*	Cold Weather*
	90° – 150° F Surface Temperature	50° – 90° F Surface Temperature	10° – 50° F Surface Temperature
1/4" – 1 1/4"	12 Min.	20 Min.	30 Min.
1 1/2" – 2 1/2"	30 Min.	45 Min.	1 Hr.
3" – 4"	45 Min.	1 Hr.	1 Hr. & 30 Min.
6" – 8"	1 Hr.	1 Hr. & 30 Min.	2 Hrs. & 30 Min.
10" – 12"	2 Hrs.	3 Hrs.	5 Hrs.

*The temperatures above are drying temperatures and should not be confused with atmospheric joining temperature recommendations and limitations. See section on "Joint Integrity."

Pressure Testing

CAUTION: Air or compressed gas is not recommended as a media for pressure testing of plastic piping systems.

Initial Low Pressure Joint Testing

Initial hydrostatic testing of PVC or CPVC solvent welded joints could be accomplished at 10% of the largest pipe's maximum non-shock operating pressure rating, corrected for ambient temperature (see page 7) after brief drying times.

PVC and CPVC Joint Drying Times for 10% Pressure Testing

Nominal Pipe Size	Hot Weather*	Mild Weather*	Cold Weather*
	90° – 150° F Surface Temperature	50° – 90° F Surface Temperature	10° – 50° F Surface Temperature
1/4" – 1 1/4"	1 Hr.	1 Hr. & 15 Min.	1 Hr. & 45 Min.
1 1/2" – 2 1/2"	1 Hr. & 30 Min.	1 Hr. & 45 Min.	3 Hrs.
3" – 4"	2 Hrs. & 45 Min.	3 Hrs. & 30 Min.	6 Hrs.
6" – 8"	3 Hrs. & 30 Min.	4 Hrs.	12 Hrs.
10" – 12"	6 Hrs.	8 Hrs.	72 Hrs.

*The temperatures above are drying temperatures and should not be confused with atmospheric joining temperature recommendations and limitations. See section on "Joint Integrity."

High Pressure Testing

PVC or CPVC solvent cemented joints can be tested for no more than 15 minutes at 100% of the largest pipe's maximum non-shock operating pressure rating, corrected for ambient temperature (see page 7) after extended drying times.

PVC and CPVC Joint Drying Times for 100% Pressure Testing

Nominal Pipe Size	Hot Weather*	Mild Weather*	Cold Weather*
	90° – 150° F Surface Temperature	50° – 90° F Surface Temperature	10° – 50° F Surface Temperature
1/4" – 1 1/4"	4 Hrs.	5 Hrs.	7 Hrs.
1 1/2" – 2 1/2"	6 Hrs.	8 Hrs.	10 Hrs.
3" – 4"	8 Hrs.	18 Hrs.	24 Hrs.
6" – 8"	12 Hrs.	24 Hrs.	48 Hrs.
10" – 12"	18 Hrs.	36 Hrs.	72 Hrs.

*The temperatures above are drying temperatures and should not be confused with atmospheric joining temperature recommendations and limitations. See section on "Joint Integrity."

Full-time Working Pressure or Maximum Test Pressure

PVC and CPVC joints may be introduced to maximum working pressure on a full-time basis after approximately four times the drying time shown above for 100% pressure testing. In compliance with ANSI B-31, Code for Pressure Piping, the system may be tested for up to one hour at one and one-half times the maximum non-shock operating pressure rating for the appurtenance with the least pressure rating in the system following the guideline drying times for fulltime working pressure. This means that Chemtrol flanges, unions and valves may be so tested at 225 psi. Or, if all devices with lower pressure ratings are isolated from the test, 2" Sch. 80 pipe, fittings and their joints could be so tested to 600 psi after correction for ambient temperature (see page 7).

General Comments and Hints

Do's and Don'ts

DO:

- Clean and prepare pipe and fitting (see Preparation for Joining, page 16).
- Use the proper applicators (see Selection of Applicators for..., page 17).
- Scrub primer into joint surfaces until a lemon peel may be curled with an edge.
- Apply Cement while the primer is still moistened.
- Maintain two wet beads at the pipe and fitting chamfers throughout joint insertion.
- Follow the instructions completely.

DON'T:

- Attempt to solvent weld in wet and/or wind without shielding.
- Solvent weld below 35° or above 90° F under direct sun exposure without precautions (see Hot and Cold Weather Cementing below).
- Discard leftover cans of solvent in trench with piping. Concentrated fumes can cause piping failure.
- Skip any priming or cementing steps.
- Skimp with cement on pipe or overdo cement in sockets, but apply enough for wet bead formation during joint insertion.

Hot Weather Cementing

Hot weather can be the nemesis of solvent cementing. As the temperature and/or wind increase, the rate of solvent evaporation quickens. Hence, it becomes more difficult to keep primed surfaces moistened. Even the cement itself can begin to "film over" prior to joining. Rather than using hot weather as an excuse to compromise the functional elements required for reliable joining, the problem must be overcome by adjusting the approach to priming, cement application and pipe insertion techniques in order to appropriately reduce the lapsed joining time. As corrective measures to combat wind and/or temperature in excess of 90° F, the following may be done:

1. Increase the crew size and organize the team to achieve speed while making no compromise to functional performance.
2. Construct a windscreen from polyethylene film or tenting around the joint and crew.
3. Shade the pipe, fittings, valves and solvent materials from the sun prior to joining in order to eliminate heat absorption by the dark color. Fittings, valves and solvent supplies may be kept in a box. Shading the pipe to be joined may be more difficult, but not impossible. Under adequate lighting, the joining may be done at night or early morning.

Cold Weather Cementing

Solvent in the primer and cement will not evaporate as readily when the temperature is below 35°/40° F. Severe scouring with a stiff bristle brush is required to work the primer solvents into the surfaces. Secondly, it takes appreciably more time for the solvents to evaporate once the joint is made. Therefore, joints must be held together longer to prevent the pipe backing out of the socket. Joints must be left undisturbed longer to prevent breaking the bond by movement. And joints must be given longer drying times before pressurization. We offer the following common sense recommendations if solvent cementing must be done when the temperature approaches freezing: Store the pipe, fitting, valves and cementing supplies in a heated area until you are ready to use them. Also, water or moisture is an enemy and frost is commonplace at near freezing temperature. So, the pipe and fittings must be kept dry prior to joining and the joints should be kept dry until the cement has had sufficient time to set – not dry, just set so they can be moved without fear of breaking the initial bond.

1. Pre-fab as much of the system as possible in a heated work area. By using flange or union connections for system erection, the number of in-place cemented joints can be minimized.
2. Field joints that must be made outside should be protected with a portable shelter, preferably black to absorb heat from the sun, and otherwise heated indirectly to produce a 40° F surface temperature on the pipe, fittings, valves and cementing supplies. The shelter should remain in place until the joint is set. And you can figure the set time to

be roughly twice what it would be for a 70° joint. Good ventilation of the shelter is an absolute safety necessity for worker health and fire prevention reasons.

CAUTION: DO NOT ATTEMPT TO SPEED THE DRYING OF THE CEMENT BY APPLYING DIRECT HEAT TO THE SOLVENT WELDED JOINT. Forced rapid drying by heating with an electric blow drier, for example, will cause the cement solvents to boil off, forming porosity, bubbles and blisters in the cement film.

Joint Integrity

In hot, mild or colder weather, if the basic joining steps are followed with discipline, the chemical fusion joining method for thermoplastic piping is extremely reliable and cost efficient. Because of significant contributions to commercial and industrial construction, both thermoplastic piping and solvent welding are here to stay. By virtue of their permanent resistance to chemical attack and undeniable economic impact, value engineering has reached the stage where even mundane processes, such as water disinfection, or exotic processes, such as bulk and dilute acid feed, are absolutely dependant upon PVC or CPVC piping with solvent cemented joints. In spite of the higher standards of skill required for industrial chemical installations, relative to the marginal standards required for domestic small diameter utility applications, we are beyond the time when joint failure can be excused because of inexperience or poor workmanship. Since the difference between cementing a joint and gluing it is common knowledge today, the 40 plus year-old technology for solvent cementing justifiably demands professional discipline in its execution. As a result, the low bidder for any PVC or CPVC piping installation can reasonably be expected to exercise control over joining performance.

Solvent Cement Usage Estimates

The PVC and CPVC solvent cement usage estimates given in the table below should only be considered as a guideline. Actual usage could vary according to a wide variety of installation conditions. Further, these estimates should in no way be used to restrict the liberal instructions in the Six Step Application Techniques starting on page 18.

Number of Joints per Container Size

Pipe Size	Pint	Quart	Gallon
½"	130	260	1040
¾"	80	160	640
1"	70	140	560
1¼"	50	100	400
1½"	35	70	280
2"	20	40	160
2½"	17	34	136
3"	15	30	120
4"	10	20	80
6"	N/R	8	32
8"	N/R	3	12
10"	N/R	N/R	10
12"	N/R	N/R	6

Thermo-Seal (Socket Fusion) Joining for Polypropylene and PVDF (KYNAR[®]) Pressure Piping Systems

Materials and Tools

Preparation of Components

A socket heat fusion joint requires pipe with a square cutoff and chamfered outside edge. Both pipe and fitting socket must be cleansed of clinging debris. For further insight see the Thermo-Fusion paragraph in the Joining Methods for Pressure Piping section on page 15. The theory of joining is extended in the Six-Steps of Joining Mechanics, which follows on page 24. The specific instructions for component preparation are provided in the Preparation of Pipe and Fittings for All Joining Methods section on page 16.

Selection of Electrical Resistance Hand-Held Heat-Tools, Bench-Mount Joining Machines and Heating Anvils (heating face sets) for Pipe and Fittings

Chemtrol offers two sizes of Hand-Held electrical resistance Heat-Tools and three sizes of Bench-Mount Joining Machines, which make socket fusion joints for Polypropylene and PVDF (Kynar[®]) pressure piping. Gas fired tools are not acceptable. The thermostatically controlled heat source for electrical tool-plates automatically maintains fusion temperatures within the recommended range. There are other electrically heated joining tools available in this country and Europe. Chemtrol Heating Anvils (heating face sets) may or may not fit onto some of this equipment. Only the heating anvils manufactured and sold by Chemtrol are acceptable for use with Chemtrol pressure pipe and fittings. Within the marketplace, one will find heating anvils for the fusion joining of IPS drainage, metric pressure and IPS Polyethylene gas piping – none of which will satisfactorily join Chemtrol fittings with pressure pipe for reasons of socket length and/or diametrical fit. Chemtrol Heating Anvils (heating face sets) are designed to diametrically interfere with the pipe, and principally the socket connection, so as to create matching geometric cones as the plastic melt swells when passing through the phase change from solid material. Therefore, NIBCO obviously can not warrant pipe, fittings and valves, which are not joined with Chemtrol Heating Anvils (heating face sets) as well as depth gages and pipe clamps, where applicable.

A set of male and female Heat Anvils (heating face sets) by Chemtrol is mounted; one on each side, to the electrically heated tool-plate of appropriate wattage capacity with clearance-holes for bolting. The Anvils are of aluminum construction, for good heat conduction, and have a permanent Teflon coating to promote the best possible release quality of the pipe and fitting polymer melts. A single 3/8" – 16 socket head bolt is included with a set of Heating Anvils (heating face sets) for pipe sizes 1/2" – 2". The 1/2" utilizes a flat head bolt while the remainder of small sizes utilize a standard bolt. Two 1/4" – 20 socket head bolts are included with each set of Anvils for pipe sizes 3" – 6". These large sizes also have a 3/8" center hole for mounting to Bench-Mount Joining Machines. The 1/4" bolts and holes, equally spaced from the center hole, are used for mounting to Hand-Held Heat-Tools. In all cases the male Anvil, for heating the socket connection, is tapped with the appropriate thread(s) to receive the mounting bolt(s). The Chemtrol Heating Anvils for pipe, fittings, flanges and valves are designed for interchangeable use on Chemtrol Hand-Held Heat-Tools or Bench-Mount Joining Machines.

A brief description of Chemtrol thermo-fusion equipment for joining Schedule 80 Polypropylene (PP) and PVDF (Kynar[®]) pipe to socket fittings, flanges, unions and valves follows:

1. Hand-Held Joining Kits for 1/2" – 2" Piping – The Multiple Size Joining Kit (MSJK – 1/2"-2") for small pipe sizes contains all of the components required for joining 1/2" to 2" socket fusion connections. The kit utilizes a TD-1 Hand-Held Heat-Tool that is operated by 110 volts (+/- 10%) of single-phase 800-watts power (fully on or off and triggered by a variable thermostat with direct reading thermometer). The kit also includes the five specified sets of male and female Heating Anvils (heating face sets), Depth Gauges, Pipe Clamp w/inserts, Pipe Cutter, Pipe Beveling tool, Timer, Thermal Blanket, Auxiliary Handle, hex-key wrenches for Heating Anvils and Pipe Clamp inserts, Thermostat Adjustment tool, and Joining Instructions – all in a rugged steel toolbox.

– The (*) Single Size Joining Kit (SSJK – 1/2"-2") for small pipe contains all of the components required for joining the designated (*) size of socket fusion connections specified. Each kit utilizes a TD-1 Hand-Held Heat-Tool that is operated by 110 volts (+/- 10%) of single-phase 800-watts power (fully on or off and triggered by a variable thermostat with a direct reading thermometer). The tool kit also includes the specified (*) size set of male and female Heating Anvils (heating face sets), (*) size Depth Gauge, Pipe Clamp w/(*) size insert, Pipe Cutter, Pipe Beveling tool, Timer, Thermal Blanket, Auxiliary Handle, hex-key wrenches for the Heating Anvils and Pipe Clamp insert, Thermostat Adjustment tool, and

Joining Instructions – all in a rugged steel toolbox. Single size kits may be expanded to include other sizes by ordering only the set of male and female Heating Anvils (heating face sets), Depth Gauge and Pipe Clamp inserts for each size to be added.

2. Bench-Mount Joining Machine for 1/2" – 2" Piping – The Model 75 Socket Fusion Tool is a manually operated machine for joining 1/2" – 2" sizes of pipe to fittings, flanges, unions and valves. Two clamps hold the pipe and one clamp, with an insertion stop, holds the corresponding fitting, flange, union or valve in the precise position for heat fusion joining. Proper use of the machine does not require the use of a Depth Gauge and Pipe Clamp, as the Hand-Held Heat-Tool does, in order to precisely heat and insert the pipe to the correct depth in the socket connection. The basic clamping and travel mechanisms of the machine, along with an electrically heated tool-plate that is operated by 110 volts (+/- 10%) of single-phase 650-watts power (fully on or off and monitored by a direct-set time-proportioning temperature controller), comes in a 23"W x 18"D x 12.5"H steel carrying case. The tool kit also includes wrenches, holding fixtures for pipe/fittings/flanges/valves, and operating instructions. A Pipe Cutter, a Pipe Beveling tool and sets of Heating Anvils (heat face sets), which are required for each size to be joined, must be ordered separately. However, instead of these purchases, the purchase of a small pipe Multiple Size Joining Kit or a Single Size Joining Kit with other selected sizes of Heating Anvil sets, Depth Gauges and Pipe Clamp inserts is recommended. While the Bench-Mount Joining Machine is very handy, it is nearly impossible to install a total system with only bench prefabrication. The Hand-Held Heat-Tool will have to be used for at least some final joint(s), so certain equipment in these kits will be required in addition to the Joining Machine.
3. Hand-Held Joining Kits for 3" and 4" Piping – The Multiple Size Joining Kit (MSJK – 3"-4") for large pipe sizes contains all of the components required for joining sizes of socket fusion connections specified. The kit utilizes a TD-3 Hand-Held Heat-Tool that is operated by 110 volts (+/- 10%) of single-phase 1650-watts power (fully on or off and triggered by a variable thermostat with a direct reading thermometer). The kit also includes two specified sets of male and female Heating Anvils (heat face sets), Depth Gauges, Pipe Clamp w/insert for the 3" size, Pipe Cutter, Pipe Beveling tool, Timer, Thermal Blanket, Auxiliary Handle, hex-key wrenches for Heating Anvils and Pipe Clamp inserts, Thermostat Adjustment tool, and Joining Instructions – all in a rugged steel toolbox.

– The (*) Single Size Joining Kit (SSJK – 3"-4") for large pipe contains all of the components required for joining the designated (*) size of socket fusion connections specified. Each joining kit utilizes a TD-3 hand-held Heat-Tool that is operated by 110 volts (+/- 10%) of single-phase 1650-watts power (fully on or off and triggered by a variable thermostat with a direct reading thermometer). The joining kit also includes the specified (*) size set of male and female Heating Anvils, (*) size Depth Gauge, Pipe Clamp w/(*) size insert, Pipe Cutter, Pipe Beveling tool, Timer, Thermal Blanket, Auxiliary Handle, hex-key wrenches for Heating Anvils and Pipe Clamp inserts, Thermostat Adjustment tool, and Joining Instructions – all in a rugged steel toolbox. A (*) SSJK – 3"-4", may be expanded to include the other size by ordering only the set of male and female Heating Anvils, Depth Gauge and Pipe Clamp insert (if required) for the other size to be added.

4. Bench-Mount Joining Machine for 1/2" – 4" Piping – The Model 3500 Socket Fusion Tool is a manually operated machine for joining 1/2" – 4" sizes of pipe to fittings, flanges, unions and valves. Two clamps hold the pipe and one clamp, with an insertion stop, holds the corresponding fitting, flange, union or valve in the precise position for heat fusion joining. Proper use of the machine does not require the use of a Depth Gauge and Pipe Clamp, as the Hand-Held Heat-Tool does, in order to precisely heat and insert the pipe to the correct depth in the socket connection. The basic clamping and travel mechanisms of the machine, along with an electrically heated tool-plate that is operated by 110 volts (+/- 10%) of single phase 1200-watts power (fully on or off and monitored

by a direct-set time-proportioning temperature controller), comes in a 32"W x 24"D x 19"H wooden shipping crate that doubles as a workbench for the unit. The tool kit also includes wrenches, holding fixtures for pipe/fittings/flanges/valves, and operating instructions. Two sizes of Pipe Cutters, a Pipe Beveling tool and sets of Heating Anvils, which are required for each size to be joined, must be ordered separately. However, instead of these purchases, the purchase of small and large pipe Multiple Size Joining Kits or small and large pipe Single Size Joining Kits with other selected sizes of Heating Anvil sets, Depth Gauges and Pipe Clamp inserts is recommended. While the Bench-Mount Joining Machine is very handy, it is nearly impossible to install a total system with only bench prefabrication. The Hand-Held Heat-Tools will have to be used for at least some final joint(s), so certain equipment in these kits will be required in addition to the Joining Machine.

5. Bench-Mount Joining Machine for 4" and 6" Piping – The Model 3600 Socket Fusion Tool is a manually operated machine for joining 4" and 6" sizes of pipe to fittings, flanges and valves. Two clamps hold the pipe and one clamp, with an insertion stop, holds the corresponding fitting, flange or valve in the precise position for heat fusion joining. Proper use of the machine does not require the use of a Depth Gauge and Pipe Clamp, as the Hand-Held Heat-Tool does, in order to precisely heat and insert the pipe to the correct depth in the socket connection. The basic clamping and travel mechanisms of the machine, along with an electrically heated tool-plate that is operated by 110 volts (+/- 10%) of single phase 1200-watts power (fully on or off and monitored by a direct-set time-proportioning temperature controller), comes in a wooden shipping crate that doubles as a workbench for the unit. The tool kit also includes wrenches, holding fixtures for pipe/fittings/flanges/valves, a set of 6" male and female Heating Anvils (heat face sets), 6" Pipe Cutter, 6" Pipe Beveling tool, and operating instructions. A 3"- 4" Pipe Cutter, a ½"- 4" Pipe Beveling tool and a set of 4" Heating Anvils (heat face sets) must be ordered separately. However, instead of these purchases, the purchase of a large pipe Multiple Size Joining Kit or a 4" Single Size Joining Kit is recommended. While the Bench-Mount Joining Machine is very handy, it is nearly impossible to install a total system with only bench prefabrication. The Hand-Held Heat-Tool will have to be used for at least some final joint(s), so certain equipment in either of these kits will be required in addition to the Joining Machine.

Distributors may purchase or rent Bench-Mount Joining Machines on a weekly or monthly basis from Chemtrol for sub-rental to installers, while Hand-Held Joining Kits may only be purchased by the distributors of Chemtrol socket thermo-fusion piping systems.

Selection of Lubricant for Heating Anvils and Cleaning Towels

The Heating Anvils (heat face sets), which mount on all electrically heated tool-plates in Chemtrol Hand-Held thermo-fusion Joining Kits and Bench-Mount Joining Machines, are coated with a permanent Teflon finish. This surface allows the sticky plastic melt, which is heated on the pipe and socket connector surfaces, to release from the Heating Anvils (heat face sets). However, it has been found that release of the hot plastic cannot be consistently achieved with the permanent coating alone, even on new Anvils. At the same time it has been learned that the retention of hot melt on the Heat Anvils (heat face sets) invites the possibility of a joint leak, and that, without thorough cleaning, greater plastic retention will result from successive joint attempts.

We have also found that Heating Anvils (heat face sets), which are occasionally sprayed (every three joints for new tools to ten joints for older Anvils) with a good quality of silicone coating will completely eliminate plastic melt retention. We consider silicone spray for new or used Anvils, along with adherence to the recommended regimen of temperature and heating time for each pipe size, to be critical for reliable joining. When any sign of plastic retention does occur, the Heating Anvils (heat face sets) may be wiped clean with brown paper toweling, or approved "clean" (sanitary) wipes (paper) for high-purity installations, and re-sprayed with silicone.

The use of cloth towels or rags for cleaning the hot Anvils (heat face sets) is discouraged. Natural fibers tend to stick to the residual plastic on the Anvils while synthetic fibers generally melt, making cleaning even more difficult.

Silicone should not be used for wash, paint, or spray systems.

Aerosol Silicone Spray, Product No. 62-4678-4930-3, is a "food grade" product manufactured by the 3M Company. A broad base of stocking industrial distributors, which are serviced through regional customer service centers, sell the product internationally. Call the 3M technical service customer center to get a list of distributors. We have found this 3M product to work better than most we have tried, to be more readily available than others, and to be an ideal choice for inert joints for high purity applications:

3M Company, Industrial Tape and Specialties Division/Adhesive Systems
Minneapolis, Minnesota
Technical Service Customer Center, Continental U. S. A., 1-800-362-3550
Technical Service Customer Center, International, 651-733-2914

Job-Site Management of Joining Equipment

Experience and practice leads to consistent achievement of centerline straightness in the joint and proper depth of pipe insertion into the socket connection. This joining technique offers no forgiveness for errors of joint alignment or depth because joint cooling occurs so rapidly that correction cannot be made once pipe insertion into the socket connection is stopped. For more insight on this matter see Six-Steps of Joining Mechanics, page 24. Socket thermo-fusion is more easily accomplished when there is sufficient space to properly secure the Hand-Held Heat-Tool and to maneuver pipes and socket connections on/into the Heating Anvils (heat face sets). Therefore, we recommend that the piping system be prefabricated, as much as possible, in an area of adequate space where the Heat-Tool can be secured in a bench vise. Bench-Mount Joining Machines are an outgrowth of the prefabrication concept. Their use is urged for larger jobs or jobs to be performed with larger pipe sizes and/or with installers having minimal experience making socket thermo-fusion joints. Bench-Mount Joining Machines automatically resolve the problems of joint alignment and depth. Manpower efficiency, scrap reduction and quality of system erection can usually absorb their rental cost. As few joints as possible should be made with a Hand-Held Heat-Tool in areas where there is limited working space. Prefabrication of components for final mechanical joining with flanges or unions should be considered in extremely tight areas.

The Heating Anvils (heat face sets) for making 6" pipe joints will mount on the large TD-3 Hand-Held Heat-Tool. There is ample heat capacity for making 6" joints. Joints can and have been made. However, properly made (good alignment and joint depth) joints are physically very difficult to execute. This is especially true for freehand final joints where one of the joining team members holds the Heat-Tool, another pushes a socket connection onto the male Heating Anvil (heat face set), while the third team member pushes the pipe into the female Anvil. A stout but steady force is required to melt those components on/into the Anvils – and they will only go on/in when melted, regardless of axial force. The real problem is developing the force to push the socket connection onto the pipe quickly enough and straight enough, so that the pipe alignment and depth of penetration into the socket is proper. Therefore, we recommend that every planning effort possible be made to prefabricate all 6" joints on the Bench-Mount Joining Machine. The next best alternative is to prefabricate the 6" joint(s) with the TD-3 Heat-Tool, held in a well-anchored bench vise. Making freehand 6" joints, as described above, should be the last option considered.

All Chemtrol heat-plates, both the Hand-Held and Bench-Mount types, have generous tolerances for heating capacity. As a result, their responses for maintaining the temperature set-point are generally unaffected by cold temperature and/or a light breeze. Only the melting time to insert the cooler piping components on/into the Heating Anvils (heat face sets) will be lengthened. Let common sense prevail at what stage a shelter must be erected for blocking wind and/or cold around the Heat-Tool point of use.

Making Equipment Ready for Joining

Field Check of Joints for Size

Socket connections are designed to produce interference with pipe and the Heating Anvils (heat face sets) in order to provide melt commingling for fusion bonding of Polypropylene and PVDF components. It should not be possible to easily slip the pipe into the socket connection past the initial socket entrance depth. In no case should it be possible to bottom the pipe in the socket prior to fusion. Before making socket thermo-fusion joints, socket connections may be field checked for proper socket dimensional tolerances, based on the above description. If a socket connection appears to be oversized, it should not be used.

Hand-Held Heat-Tool Set-Up

Pipe size is stamped into the mounting-flange face of both male and female Heating Anvils (heat face sets). Proper diameter of Anvils may be field checked by placing the female Anvil on a chamfered pipe end. The pipe should enter about half way into the unheated Anvil socket before meeting resistance. The pipe should not freely bottom in the Anvil socket. Place the male Heating Anvil in the female Anvil. It should bottom freely, but an extremely small amount of radial "play" should be detectable.

Install the set of male and female Heating Anvils (heat face sets) that are required for the joint size desired on either side of the heat-plate. Secure them as follows: 1/2" size – A 3/8" standard socket flat-head center bolt is screwed into the male Anvil; 3/4" through 2" sizes – A 3/8" standard socket-head center bolt is screwed into the male Anvil; 3" and 4" sizes – two 1/4" standard socket-head bolts, evenly spaced from the center hole, are screwed into the male Anvil.



Insert the electrical plug on the Heat-Tool into a grounded 110 VAC, single phase, 15 AMP source. Allow the tool to stabilize at operating temperature, which is read directly from the mounted temperature gauge. Heat-Tools are pre-set to 500° F (260° C) at the factory. Tool temperature may be adjusted by turning the thermostat adjustment screw with the tool provided in the Hand-Held Joining Kit. This tool is similar to a screwdriver blade, the shank of which has been bent 90°. A clockwise turning motion will reduce the temperature while a counterclockwise turning motion will increase the temperature.

CAUTION: One-quarter turn (90°) of the adjustment screw will produce a temperature change of approximately 25° F. Following a temperature adjustment, wait for stabilization at the new temperature. Assuming the Heat-Tool is correctly set for 500° F, one full counterclockwise turn of the adjustment screw will raise the tool temperature to 600° F. We do not recommend a temperature setting higher than 600° F under any circumstances. To back the adjusting screw any further from its threaded hole than the equivalent temperature setting of 600° F could result in the screw becoming totally disengaged from the thermostat.

When the screw is fully disengaged, the thermostat will not shut off power to the heater rods, and the temperature will eventually rise to 900° F, before the heating element begins to burn out. The adjustment screw cannot be re-engaged. Therefore, the Heat-Tool will have been rendered unusable (see Equipment Maintenance at the end of this chapter). Faster joining will not result from higher temperatures than those recommended.



Give the Heating Anvils (heat face sets) a good spraying of silicone lubricant so that it will have a chance to "burn in" while they are heating up.

IMPORTANT: Socket thermo-fusion joints, which leak or lack sufficient strength, are unlikely if the following rules are followed:

WHEN the heat-tool is operated within the guidelines for temperature and exposure time (pipe and socket connection to be in "home" position on the Heating Anvils) recommended in the table on the next page for specific pipe sizes,

AND the Six Steps of Joining Mechanics are followed.

Excessive heating temperature and/or exposure time will result in excessive melting below the surfaces of the socket connection I.D. and the pipe OD. Under such conditions, the inserted pipe will scrape melt swell from the socket wall and push it into the fitting waterway creating the potential for large pressure drops at the connections. Even worse, globs of melted plastic may adhere to the Heating Anvils (heat face sets) and be pulled away from the socket and/or pipe surface(s), resulting in an unsatisfactory joint. Fusion attempts with insufficient heating temperature and/or exposure time will result in incomplete melt penetration of the socket and pipe surfaces, resulting in excessive force being required to push the joint together. The lack of melt swell creates the potential for leakage and inadequate bonding to satisfy the joint shear stress presented by hydraulic end-load as a function of internal system pressure. (Heating exposure times in the following table are defined to begin after the pipe and socket connection have been completely placed in the home position on the Heating Anvils (heat face sets). See Step 4 in the Six Steps of Joining Mechanics for Hand-Held Heat-Tools for the definition of the home position; pg. 24.

Thermo-Fusion Socket Heating Times

Polypropylene				PVDF			
Size	Time (sec)	Temp ° F	Temp ° C	Size	Time (sec)	Temp ° F	Temp ° C
1/2"	5	495-505	257-263	1/2"	5	495-505	257-263
3/4"	5	495-505	257-263	3/4"	5	495-505	257-263
1"	5	495-505	257-263	1"	5	495-505	257-263
1-1/2"	5	495-505	257-263	1-1/2"	5	495-505	257-263
2"	5	495-505	257-263	2"	5	495-505	257-263
3"	7-9	500-510	260-266	3"	25-35	510-530	266-277
4"	12-15	500-510	260-266	4"	40-50	510-530	266-277
6"	15-20	500-520	260-271	6"	50-60	540-560	282-293

Heating times start after pipe and fitting are completely on heater faces (fitting face not to touch base of male heat face).

Chemtrol recommends using a fusion joining machine for sizes 3" and larger.

Inserts Set-Up in Pipe Clamp for Correct Pipe Size

While you are waiting for the Heat-Tool to come to temperature, select the inserts for the pipe size intended for joining. Pipe sizes are not stamped on the inserts, but figuring out the correct set for bolting into a Pipe Clamp is not difficult when you understand that the 2" and 4" pipe sizes do not require a set of inserts. Each of these Pipe Clamps is a vise-grip with clamshells, which match the respective pipe diameters, welded to the nosepiece of the pliers. The 1 1/2", 1", 3/4" and 1/2" insert sets are bolted into the 2" Pipe Clamp while the 3" insert set is the only one to bolt into the 4" Pipe Clamp. The insert sets should be stored in the respective Hand-Held Joining Kit toolboxes for small and large diameter pipe. In the case of tool inserts for the smaller pipe sizes, the thickest obviously are for 1/2" and the thinnest are for 1 1/2" pipe. If in doubt, you may fit the inserts to the pipe by hand until you find the pair that is the correct size.

The purpose of the Pipe Clamp is to provide a precise measurement on the pipe for its insertion into the Heating Anvil (heat face set) and for its insertion into the socket connection upon joining. Please note that there is some play in the lateral action of the vice-grip pliers. Note also that there is a bolt hole clearance in the clamshells for attachment of the inserts to the tool. The Pipe Clamp may be placed on the top, bottom, or opposite side of the pipe from any position. One must simply visualize the reference orientation so that a flush face of the Pipe Clamp will be available for the reference surface of precise pipe insertion.

Tools and Equipment

- Pipe Cutting Tool (see Preparation for Joining, pg. 16)
- Pipe Beveling tool (see Preparation for Joining, pg. 16)
- Hand-Held Heat-Tools (see Selection of Hand-Held Heat-Tools, Bench-Mount Joining Machines and Heating Anvils for Pipe and Fittings, pg. 21; and Six Steps of Joining Mechanics for Hand-Held Heat-Tools, pg. 24)
- Depth Gauges (see Six Steps of Joining Mechanics for Hand-Held Heat-Tools, pg. 24)
- Pipe Clamps w/inserts (see Six Steps of Joining Mechanics for Hand-Held Heat-Tools, pg. 24 ; and Inserts Set-Up in Pipe Clamp for Correct Pipe Size, pg. 23)
- Heating Anvils for male and female piping components (see Six Steps of Joining Mechanics for Hand-Held Heat-Tools, pg. 24; and Hand-Held Heat-Tool Set-Up, pg. 23)
- Timer (see Six Steps of Joining Mechanics for Hand-Held Heat-Tools, pg. 24; and Table of Recommended Heat-Tool Temperature & Exposure Time, pg. 23)
- Thermal Blanket (see Six Steps of Joining Mechanics for Hand-Held Heat-Tools, pg. 24; and Maintenance of Equipment, pg. 28)
- Auxiliary Handle for Heat-Tool (see Six Steps of Joining Mechanics for Hand-Held Heat-Tools, pg. 24)
- Hex-Key wrenches for Heating Anvils and Pipe Clamp inserts (see Hand-Held Heat-Tool Set-Up, 22; and Inserts Set-Up in Pipe Clamp for Correct Pipe Size, pg. 23)
- Thermostat Adjustment tool (see Hand-Held Heat-Tool Set-Up, pg. 22)
- Joining Instructions (see Selection of Hand-Held Heat-Tools Bench-Mount Joining Machines and Heating Anvils for Pipe and Fittings, pg. 21; Job-Site Management of Joining Equipment, pg. 22; and Six Steps of Joining Mechanics for Hand-Held Heat-Tools, pg. 24)
- All Above Equipment Contained in Hand-Held Joining Kits for Large and Small Pipe Sizes (see Selection of Hand-Held Heat-Tools, Bench-Mount Joining Machines and Heating Anvils for Pipe and Fittings, pg. 21)
- Deburring tool (see Preparation for Joining, pg. 16)
- Pipe Cleaning solvent (see Preparation for Joining, pg. 16)
- Paper Toweling or Clean Wipes (see Preparation for Joining, pg. 16; and Selection of Lubricant for Heating Anvils and Cleaning Towels, pg. 22)
- Silicone Lubricant (see Selection of Lubricant for Heating Anvils and Cleaning Towels, pg. 22; and Six Steps of Joining Mechanics for Hand-Held Heat-Tools, below)

Six Steps of Joining Mechanics for Hand-Held Heat-Tools Crew Size

The Hand-Held Heat-Tool may be used for the prefabrication of most system joints at a heavy workbench where the Heat-Tool is clamped into and rigidly held by a solidly attached bench vise. Bench-Mount Joining Machines are an outgrowth of the prefabrication concept, and their use is urged for larger jobs or installations involving larger pipe sizes and/or with installers having minimal experience making socket thermo-fusion joints (see Job-Site Management of Joining Equipment pg. 22). When prefabricating with a Hand-Held Heat-Tool the crew size will be two when the team member handling the pipe can easily hold the assembly that is already attached to the pipe. A very experienced installer may be able to make a 1", or smaller, joint alone if the pipe extension is short, but we recommend a minimum of two for a joining team. Or, the crew size will be three if a third team member must support and hold proper orientation of the assembly that is attached to the pipe.

When using the Heat-Tool in a freehand manner, making final joints in-place, one team member, using the Auxiliary Handle attached to the heat-plate, holds the Heat-Tool rigidly, another pushes a socket connection onto the male Heating Anvil, while the third team member pushes the pipe into the female Anvil. When prefabricating on a Bench-Mount Joining Machine, it only takes one team member to clamp the pipe and socket connection into the machine, and to operate it for creating a joint. But, a second team member is recommended for supporting and holding proper orientation of the assembly that is attached to the pipe.

The Heating Anvils will instantly vaporize moisture when they are at joining temperature. Therefore, joint surfaces must be dry at the time of joining.

For the sake of clarity of these instructions, we are assuming the usual installation crew of two, while prefabricating at a workbench. The first installer is in charge of the socket connection and will be referenced as installer #1, for simplicity. The second team member is in charge of the pipe end during the joining process and he shall be referenced as installer #2.

1. Installer #2 gives the Heating Anvils (heat face sets) a light fogging of silicone spray, making sure that the spray is directed into the Pipe Anvil and that some of the fog is directed at the top, bottom and both sides of the Fitting Anvil. Meanwhile, installer #1 grasps the pipe and inserts the pipe end to the bottom of the Pipe Gauge. Wipe excess spray from the Anvils with a clean paper towel. (See Selection of Lubricant for Heating Anvils and Cleaning Towels, pg. 22)



2. Installer #1 may need to adjust the clamp screw on the pliers, which governs the clamp opening. The Pipe Clamp must snugly grasp the pipe, but not crush it out-of-round. He should then attach the Pipe Clamp w/insert to the pipe by butting the flush surface (see Inserts Set-Up in Pipe Clamp, pg. 23) against the face of the Depth Gauge while installer #1 continues holding the Gauge against the pipe end. Installer #2 should use his index and middle fingers to push both halves of the Pipe Clamp to insure they are flush against the Depth Gauge face.



3. Simultaneously, installer #1 should place the pipe and installer #2 should place the socket connection squarely on the Heating Anvils (heat face sets) so that the ID of the connection and the OD of the pipe are in contact with the heating surfaces. Care should be taken to insure that neither the pipe or socket connection are cocked as they are pushed in/on the Anvils. The Pipe Clamp's simple job is to precisely mark the location of socket depth on the pipe, so installer #1 should not use the tool as a push bar. Don't allow the clamp to slip on the pipe and lose the opportunity for making a quality joint. The socket connection will always have more initial interference with its Anvil than the pipe, so the force applied by installer #2 will probably be less than the force required from installer #1 as they match insertion rates on/in their respective Anvils. The plastic components will only slide on/in the Anvils when the plastic melts and allows forward progress. Therefore, the plastic components should not be moved by rocking or twisting them on their Anvils in an effort to hasten penetration. A solid steady force is all that is required. It is the responsibility of installer #2 to penetrate at the same rate as installer #1 so that both arrive at the same time at the home position on the Anvils. Progress is good when both installers see that the plastic melt bead forming on the male Anvil at the entrance radius/chamfer of the socket is uniform around the socket entrance.



4. Home positions on the Heating Anvils (heat socket set) are when the melt bead in the entrance radius/chamfer of the socket connection touches the mounting flange of the male Heating Anvil and the Pipe Clamp uniformly touches the face of the female Heating Anvil. **DO NOT SQUEEZE THE MELT BEAD. YOU ARE IN THE HOME POSITION.** With practice, installers will learn that the melt bead is an excellent reference for proper alignment. As the joint components of the installers approach their respective home positions of insertion on/in the Heating Anvils the installer #1 should make sightings of his bead distance from home position on top, bottom and both sides of the mounting flange. Installer #1 should insure the bead touches the Anvil flange – completely around the fitting – all at once. As the touch is made, he should stop. Installer #2, equaling the rate of his pipe penetration with the rate of fitting



penetration in/on the respective Anvils, should also make 360° sightings of his distance from the Pipe Clamp to Anvil face. Installer #2 must insure the face of his Anvil touches the Pipe Clamp – completely around the pipe – all at once. This is the first reason for insuring that one end of the Pipe Clamp w/inserts is a true surface. As the touch is made he should also stop. Both installers should hold their positions for the prescribed time in the Table of Recommended Heat-Tool Temperature and Exposure Time, pg. 23. Installer #1 must continue to monitor the melt bead, while holding the socket connection in the home position. Installer #2 must concentrate on holding the Pipe Clamp flush against the face of the female Heating Anvil to allow heat to transfer into the pipe and fitting surfaces to be fusion bonded.

NOTE: The dwell time in the home position on the Heating Anvils at 500° F, for both PP and PVDF in pipe sizes ½" through 2", is five seconds. Use a timer, watch or voice count to control the duration of this step. It is critical that this time be maintained.

5. As soon as the proper time in the home position has expired, simultaneously remove the pipe and fitting straight away from the Heating Anvils. Only a thin layer of melt actual melt will exist on the heated surfaces. Avoid mashing the melt to one side or the other on either the pipe or socket connection while removing them from the Anvils. Upon removal from the Heating Anvils installer #1 should immediately push the socket connection, squarely and fully and without purposeful rotation, onto the pipe. The pipe must be held steady and in the horizontal plane by installer #2. This assumes that prefabrication will normally be attached to the other pipe end. It is unproductive for both installers to actively push the components together. The ease of making straight joints is much greater when one team member blocks his component and the other team member aggressively pushes his component in/on the other stationary component. The joining team must mutually decide which shall block and which shall push the joint together before attempting the joint, because speed is of the essence in removal of the components from the Heating Anvils and insertion of the pipe in the socket connection.



As the pipe is steadily inserted into the socket connection, the flush faces of the Pipe Clamp may again be used as the reference plane to sight against the approaching melt bead at the face of the fitting. Be sure to maintain the forward motion of pipe insertion into the socket, because once stopped, rapid melt cooling will prevent any restart of insertion. The team member acting as the pusher must insure that the melt bead around the fitting uniformly touches the flush Pipe Clamp – all at once. **DO NOT SQUEEZE THE MELT BEAD. THE JOINT IS IN THE HOME POSITION.**

6. Hold the completed joint in the home position for about 10 seconds – a little longer for larger sizes – to permit cooling of the plastic bond. This will prevent the pipe from moving back in the tapered socket while the inner surfaces are fluid. Now that the joint is completed, remove the Pipe Clamp and begin preparations for the next joint. It is important that the Heating Anvils be kept as clean as possible. Any residue left on the Anvils should be removed immediately by wiping with a paper towel. (See Selection of Lubricant for Heating Anvils and Cleaning Towels; pg. 22.) Check the Heat-Tool temperature to make sure that that it is stable at the prescribed setting. (See Hand-Held Heat-Tool Set-Up; pg. 23.) If residue deposits on the Heating Anvils following the making of joints persists, try increasing the silicone spray to thoroughly coat the applicable surfaces and/or reduce the prescribed heating time by increments of 10 – 20%. Be cautious in the reduction of time for sizes 2" and below. Do not waver from the prescribed temperature settings. (See Recommended Heat-Tool Temperature & Exposure Time; pg. 23.)



CAUTION: Molten plastic material can cause severe burns. Avoid contact with the hot plastic and heat-tool. It is always a good idea to drape a thermal blanket over a hot heat-tool – Hand-held or bench-mount – when the installers must leave the work area. A – Caution Hot – sign, even crudely written on a cardboard box flap and posted on the workbench, is desirable when absent.

Fulltime Working Pressure or Maximum Test Pressure, Maintenance of Equipment, and Construction Tips

These issues will be addressed at the end of the following sections concerned with the use of Bench-Mount Joining Machines.

Superior Design and Construction Features of Bench-Mount Joining Machine

Description of Basic Components

Bench-Mount Joining Machines are an outgrowth of the prefabrication concept. Each of the three Chemtrol machines (see Selection of Electrical Resistance Hand-Held Heat-Tools, Bench-Mount Joining Machines and Heating Anvils for Pipe and Fittings; pg. 21) have a temperature controlled heat-plate attached to the machine, which can be swung from centerline of the machine to a rear position that does not interfere with machine travel perpendicular to the heat-plate. The Teflon clad Anvils (heat face sets), which heat pipes and socket connections, are used interchangeably for Hand-Held heat-plates and Bench-Mount heat-plates. All sizes of Heating Anvils (heat face sets) mount to Bench-Mount heat-plates with 3/8" standard bolts that pass through a clearance hole in the dead center of its heat-plate.

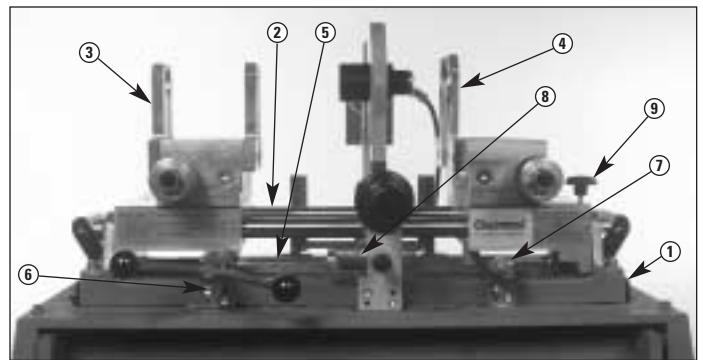

Features Forming the Foundation of Machines

No.	Name / Element
1	Machine base, Aluminum casting for rigidity and minimum weight during movement
2	Two Steel Rods with hard chrome finish, which are firmly attached to each end of machine base, act as the machine ways.
3	Pipe Sled, rides freely and precisely toward or away from center on ways through Bushings
4	Fitting Sled, rides freely and precisely toward or away from center on ways through Bushings
5	Rack and Pinion provides in-and-out movement of the sleds on the machine ways
6	Hand-Wheel, machine-tool spoke type, turned by operator clockwise or counter-clockwise respectively, to drive both sleds together or apart at same rate – each a slave to the other.
7	Depth Gauge Stroke-Limiter, spring-loaded plunger with latch on operator's right, which he can depress to engage the fitting sled as the operator brings both sleds together. This position correctly measures pipe projection from the entrance of a socket connection to the Prismatic Pipe Clamping Jaws
8	Joint Insertion Stroke-Limiter assembly, passes through the pedestal block that holds the heat-plate handle. It is located in front of the operator. An indexable steel tube having notches cut into the periphery at the end of the tube, which correspond to the joint insertion lengths for each pipe size, will be caught by an arresting arm, mounted on the bottom of the pipe sled.
9	Knob Handle for set-screw, which locks the pipe sled in place by bearing on the front machine Steel Rod way.

The tops of the fitting and pipe sleds are finished flat, relative to their bushing bearing holes. Each sled has mounted upon it a miniature Vise, which simultaneously advances or retracts the Holder-Blocks on each sled by the operator turning a Lead-Screw, fitted through Brass Bushings in each Holder-Block. Each Vise is centered on its sled by means of a slot in the sled and a dovetail projecting from the bottom of the Vice Base. This locating concept also insures that the independent action of each Vise is perfectly perpendicular to the transverse line of movement for the sleds.

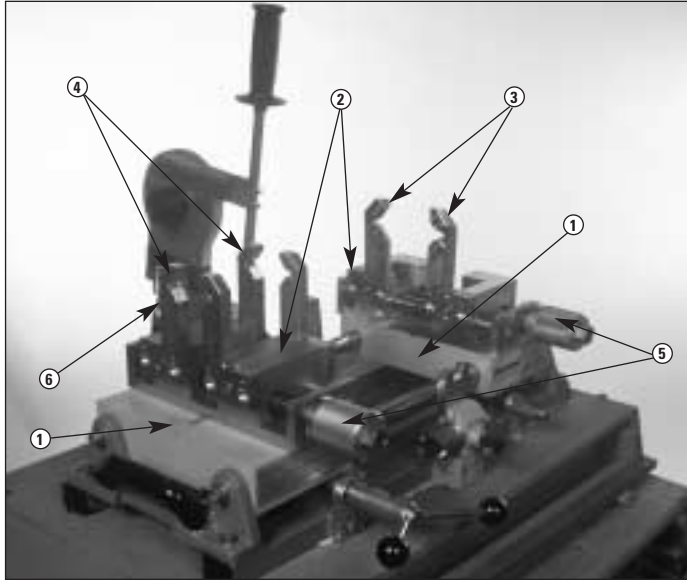

Features of the Pipe and Fitting Clamping Visas

No.	Name / Element
1	Transverse Fitting and Pipe Vise Bases, permanently located in the longitudinal and horizontal planes by a slot in the top of the sleds and a dovetail projecting from the bottom of Vise Bases
2	Two Pair of Vice Holder-Blocks, each pair forming the Fitting Vise on the operator's right or the Pipe Vise on the operators left. The Clamping Jaws mount to the Holder-Blocks such that the four tangent points on each set of Jaws grasping the product (pipe or fitting) have equal radii to the dead center of the product, which coincides with the centerline of the machine
3	Pair of Fitting Prismatic (vee type) Clamping Jaws with stops for locating the face of the fitting and insuring alignment of socket connection within the clamping Jaws – operator's right on the machine. Each set of Jaws handles a range of fitting sizes; ½"-2", 2"-4", 4" flange-only for 3500 machine and 4"-6" respectively
4	Dual Pair of Pipe Prismatic Clamping Jaws, insuring alignment of pipe within the Clamping Jaws – operator's left on machine. Each set of Jaws handles a range of sizes; ½"-2", 2"-4" and 4"-6"
5	Two Handles, which the operators uses to advance or retract the pair of Holder-Blocks via the Lead-Screw, one each for the fitting and pipe Visas
6	Electronic Temperature Controller for the heat-plate permits setting the temperature directly, which the Controller can be expected to hold within several degrees

Making a Bench-Mount Machine Ready For Joining Assumptions

Before the job of installing Polypropylene or PVDF is undertaken, it must be assumed that the detailed instructions, which come with the Bench-Mount Joining Machine, have been read and understood by the team that will operate the machine, or that they have otherwise been instructed by Chemtrol personnel or by their distributor's personnel. The second assumption is that the Bench-Mount Joining Machine, which was selected, includes the range of pipe size(s) on the job (see Selection of Electrical Resistance Hand-Held Heat-Tools, Bench-Mount Joining Machines and Heating Anvils for Pipe and Fittings; pg. 21). Both the Joining Machine and the socket connections of Chemtrol fittings and valves require that Chemtrol brand Heating Anvils (heat face sets) be used on the machine to successfully make joints with IPS sized pipe.

Machine set-up

After removal of the top of the steel storage case for the Model 75 (½" – 2" pipe sizes) Joining Machine, the machine may be picked up by the convenient handles at each end of the machine base and placed on a sturdy workbench at the job-site. Since all tools and fixtures required for the machine are located in the tool drawer housed in the machine base, the storage case can be set aside during use. For both Models 3500 (½" – 4" pipe sizes) and 3600-2 (4" and 6") the storage case is wooden. When the tops of these cases are removed, they may be set on the floor and the bottom of the case with the machine and its tool drawer set on its top, making an ideal workbench.

The heat-plate must be swung from its position on the Joining Machine centerline to its free position at the backside of the machine. Install the set of male and female Heating Anvils (heat face sets) that is required for the joint size desired. Pipe size is stamped into the mounting-flange face of both male and female Heating Anvils. When facing the machine on the operators side, the male Anvil for heating the fitting socket connection is mounted on the right side of the heat-plate and the female Anvil for heating the spigot or pipe end is mounted on the left side of the heat-plate. All sets of Heating Anvils, except the ½" size, are secured with a 3/8" standard socket-head bolt, which passes through center clearance holes in the female Anvil and heat-plate and screws into the male Anvil. For the ½" Heating Anvils, a 3/8" standard socket flat-head center bolt is screwed into the male Anvil.

The correct Pair of Fitting Prismatic Clamping Jaws and the Two Pairs of Pipe Prismatic Clamping Jaws must be mounted to the Holder Blocks of the Fitting and Pipe Visas respectively (see Design and Construction Features Nos. (3) and (4) in the table for Pipe and Fitting Clamping Visas; at left).

Then, insert the electrical plug on the machine into a grounded 110 VAC, single phase, 15 AMP standard electrical source. If the red power switch on the side of the temperature controller is in the OFF position, snap the switch to the ON position. When the power is ON, the operational switch-button will glow red and the small green indicator, adjacent to the red power switch, will glow green with the indication that the power to the heat-plate is fully ON. When the instrument begins to control the temperature within the range of set point, the green light will begin to blink ON and OFF. This means that the machine is ready to make joints.

Next, look closely at the temperature set point, which the pointer-arrow in the center of the window indicates on the white temperature dial. This set-point window is located on the same side of the controller and between the glowing lights. If the set point does not agree with the recommended joining temperature for the size of pipe and material to be jointed, adjust the instrument to the precise temperature recommended (see pg. 23). At the foot of the set point window of the controller, there is a small plastic button with a small screwdriver slot. Turning this button, with the small screwdriver in the tool drawer of the Joining Machine, will turn the temperature dial under the pointer-arrow in the set point window. Simply turn the temperature dial until the desired temperature is indicated by the pointer-arrow and let the controller instrument do the rest.

Now, give the Heating Anvils a good spraying of silicone lubricant and let it 'burn in' while the Anvils are heating up. Next, be sure that the proper pipe size is selected on the Joint Insertion Stroke-Limiter (see Design and Construction Feature No. (9) in the table, Forming the Foundation of Machines; pg. 25). To set, pull out the latch, at the front side of the pedestal block that holds the heat-plate handle. While holding the spring-loaded latch out, turn the knurled handle at the right side of the pedestal in either direction until the correct pipe size, inscribed around the Joint Insertion Stroke-Limiter notched tube at the left of the pedestal, faces straight up under the red bead on the pedestal. Then release the latch of the assembly, so that its nosepiece may engage the notched tube and hold it in the proper position to catch the Stroke-Limiter arresting arm, mounted on the pipe sled.

In the meantime, while the operator tends to the machine, his mate will relocate the pipe, fittings, and valves to the near proximity of the Bench-Mount. Then the mate should clear the area surrounding the machine location so the prefabricated modules may be turned this way and that as additional joints are added. Finally, the mate should pull several of the first lengths of pipe to be joined along with the first few fittings or valves to be joined and prepare them for the joining process. As with the Hand-Held unit, water is deleterious to the joining process, so the joint surfaces must be dry when joining (see Preparation of Pipe, Fittings and Valves for All Joining Methods, pg. 16). The joining team is now ready to make a joint with the Machine.

Six Steps of Joining Mechanics for Bench-Mount Joining Machines

Crew Size

As with the prefabrication of joints with a Hand-Held Heat-Tool clamped into a bench vise, the crew size will be two. One team member (the machine operator) will locate and clamp the fitting socket connection into the machine and attend to joint-making operation. The other team member (operator's assistant) will support the opposite end of pipe to be joined while the operator is clamping the end of pipe to be joined in the machine and attending to joint-making operation. There will be in-and-out motions of the joined pipe in the joint-making process; therefore the assistant must coordinate the movement of the machine with his supporting duty for the prefabricated module. If there is a prefabrication module already attached to the assistant's pipe end, he must make sure he holds his prefabrication to face the proper direction so that the orientation of the end to be joined has the correct relationship with the fitting to be joined.

As begun above, we will refer to the machine operator and his assistant to distinguish how a crew of two makes joints on a Bench-Mount Joining Machine.

1. The operator gives the Heating Anvils (heat face sets) a light fogging of silicone spray, making sure that the spray is directed into the pipe Anvil and that some of the fog is directed at the top, bottom and both sides of the socket connection Anvil. Should the operator overspray, such that droplets have formed, he should wipe the Anvils with a clean paper towel (see Selection of Lubricant for Heating Anvils and Cleaning Towels, pg. 22).

Then the operator must drive the pipe and fitting sleds apart, using the spoke type machine tool hand-wheel at his left on the machine. With his right index finger he should depress the plunger of the Depth Gauge Stroke-Limiter until the button on the other end of the plunger is free to fully project beyond the slotted arresting arm at the bottom of the fitting sled (see Design and Construction Feature No. (8) in the table, Forming the Foundations of Machines; pg. 25). While continuing to depress the plunger, he should now use the hand-wheel to advance the sleds toward each other until the button head of the plunger is inside the slot in the arresting arm. At this point the plunger may be released to pop outward and catch against the arm slot. Finally, when the Depth Gauge Stroke-Limiter arresting arm firmly rests against the shank of the plunger, the inward motion of the sleds will be stopped. Now, he may tighten the knob handle of the set-screw on the far rear top of the fitting sled in order to lock the sleds in the ideal Stroke-Limiting position (see Design and Construction Feature No. (10) in the table, Forming the Foundation of Machines; pg. 25).

2. The operator sets the socket connection of the fitting his assistant has prepared for joining into the Pair of Fitting Prismatic Clamping Jaws (see Design and Construction Feature No. (3) in the table for Pipe and Fitting Clamping Vises; pg. 26). He must square the face of the socket connection against the stop-plates at the end of the Jaws closest to center machine while he tightens the Fitting Vise with the Handle on the front of that Vise. Concurrently he must make sure that the orientation of other connections of the fitting agrees with the piping design relative to the design orientation of the fitting that will/has be/been placed on that opposite pipe end. Once the operator is confident that he has good alignment of the socket connection in its Vise, he must cinch the Vise

Handle as strongly as he can with one hand, so that the fitting will not slip under joining force.

3. The assistant lifts and maneuvers the opposite end of the pipe he/she has prepared for joining. Meanwhile, the operator sets the pipe end to be joined into the Dual Pair of Pipe Prismatic Clamping Jaws (see Design and Construction Feature No. (4) in the table for Pipe and Fitting Clamping Vises; pg. 26). The operator must place the square cut, beveled, deburred and cleaned pipe end against the radius/chamfer of the socket connection in the Fitting Vise while he tightens the Pipe Vise with the Handle on the front of that Vise. Concurrently, he must instruct his assistant with maneuvers that assure alignment of the pipe in its Vise such that there is 8-point contact with the Pipe Vise Clamping Jaws, as well as contact with the entrance of the socket connection. Once the operator is sure that he has good alignment of pipe in its Vise, he must cinch the Vise Handle as strongly as he can with one hand, so that the pipe will not slip under joining force.

The positioning of pipe against the fitting in this step eliminates the need for a Pipe Clamp and Depth Gauge, which is required for Hand-Held Heat-Tool joining. Perfect alignment of pipe and fitting in the Clamping Jaws of the Bench-Mount Machine insures perfect finished joint alignment, which is the most difficult outcome to learn when using a Hand-Held Heat-Tool.

4. To make the joint, the operator must release the set-screw clamping the fitting sled to the travel rod by turning the knob on top of the outer front of the sled. Next, he should back the pipe and fitting sleds away from each other with the machine tool hand-wheel. As both sleds move away from the machine center, the noise made by the plunger of the Depth Gauge Stroke-Limiter may be heard as its nose button is released by the slotted arresting arm and the plunger is sprung to its released position.

After full retraction of the sleds, the operator must grasp the handle of the machine's Heat-Tool and swing the assembly into the centerline of the machine and rest the handle in the slot of the pedestal at the center front of the machine.

Now, the operator must turn the machine tool hand-wheel in the clockwise direction to bring the pipe and socket connection toward the center of the machine. The male and female Heating Anvils (heat face sets) should have nearly perfect alignment with pipe and socket connection. If not, there is some latitude for horizontal movement by pushing or pulling on the Heat-Tool handle to make the necessary adjustment. Once the Heating Anvils and products to be joined are lined up, the assistant continues to work in coordination with the operator as he exerts reasonable force on the hand-wheel to drive the Anvils in/on the products to be joined. The operator should continue the steady hand-wheel force, accompanied by movement of the sleds as plastic melting takes place, until the melt bead, formed in the radius/chamfer of the socket connection, touches the mounting flange of the male Heating Anvil. **THIS IS THE HOME POSITION. DO NOT SQUEEZE THE MELT BEAD.** The operator must continue to remember to not squeeze the melt bead, while holding the Hand-Wheel steady in the home position to allow heating of the surfaces to be joined for the prescribed time in the Table of Recommended Heat-Tool Temperature and Exposure Time; pg. 23.

Note: The dwell time in the home position on the Heating Anvils at 500° F, for both PP and PVDF in pipe sizes ½" through 2", is five seconds. This time sequence is so short that it is impractical to reach the home position on these sizes and instantly start the Timer to count down five seconds. After minimal practice with a timer or watch, an installer can learn to speak the football quarterback's cadence of, hut – one, hut – two, hut – three, etc. to count off five seconds even more accurately than moving the hand on command to activate a Timer and properly measure the time interval. Or, the juvenile cadence of, one-thousand-and-one, one-thousand-and-two, etc. works equally well for others. Certainly the cadence count would not be more accurate for 13 seconds or more. We leave it up to you, which method to use, for eight seconds, but by all means, adopt the discipline of using the Timer for longer time intervals.

- As soon as the proper time in the home position has expired, the operator must again coordinate with his assistant to move the heated product back from the Heating Anvils. The operator does this by quickly turning the Hand-Wheel counterclockwise. As soon as the pipe and fitting sleds have been retracted, the operator must quickly lift the Heat-Tool handle and swing it from the machine centerline to its resting place behind the machine.

Now the machine has been cleared for the operator and his assistant to move the pipe sled forward again to make the fusion joint. The operator does this by quickly turning the Hand-Wheel clockwise again. As resistance is met from the pipe being inserted into the socket, the operator must never let the forward motion stop. If the motion stops, it can be next to impossible to start again in order to complete the joint. Do not worry though. The force required for pipe insertion is no greater than the force to push the products onto the Heating Anvils. Quickness and steady force are the secrets for success. The machine's joining stroke will be terminated when the arresting arm on the pipe sled strikes the variable length tube of the Joint Insertion Stroke-Limiter assembly. You will recall that the notch on the tube, corresponding to joint pipe size, was selected in Step 1.

- Hold the completed joint in the home position for about 10 seconds – a little longer for larger sizes – to permit cooling of the plastic bond. This will prevent the pipe from moving back in the tapered socket while the inner surfaces are fluid. If the operator would prefer to start making preparations for the next joint before cooling is complete, he can again tighten the Knob of the set-screw, on the far right of the fitting sled, which locks the sleds in place. Just remember to loosen the Knob before resetting the machine for the next joint, as in Step 2.

It is important that the Heating Anvils (heat face sets) be kept as clean as possible. Any residue left on the Anvils should be removed immediately by wiping with a paper towel. Check the Heat-Tool temperature to make sure that it is stable at the prescribed setting. If residue deposits on the Heating Anvils – following the making of joints – persists, try increasing the silicone spray to thoroughly coat the applicable surfaces and/or reduce the prescribed heating time by increments of 10-20%. Be cautious in the reduction of time for sizes 2" and below. Do not waver from the prescribed temperature settings.

Now that the joint has sufficiently cooled, the operator should remove it from the machine by loosening the Fitting Vise first and then the Pipe Vise.

Fulltime Working Pressure or Maximum Test Pressure

The strength of a socket fusion joint develops as the material in the bonded area cools to the extent that there is zero temperature gradient across the socket connection and pipe joint. One way of determining this is to hold the socket connection hub to your cheek, and determine whether the plastic feels cool relative to your skin temperature. Certainly, within an hour after the final joint, the heat will have dissipated from all joints. In compliance with ANSI B-31, Code for Pressure Piping, the system may be tested for up to one hour at one and one-half times the maximum design operating pressure for the system, but not more than one and one-half times the maximum non-shock operating pressure rating for the appurtenance with the least pressure rating in the system. This means that Chemtrol flanges, unions and valves may be so tested, after correction for ambient temperature, at up to 225 psi. Or, if all devices with lower pressure ratings are isolated, 2" Sch 80 PP pipe, fittings and their joints could be so tested, after correction for ambient temperature, at up to 300 psi; (see pg. 7). As soon as testing is complete the PP or Kynar (PVDF) system may be commissioned for continuous operation. There should be no leaks when the system is hydro-tested. We strongly recommend that no testing with air or other gas because of safety implications. Should any leaks be found refer to pg. 29 for instruction concerning the conditions and method of repair.

Maintenance of Equipment

As much of the equipment in both the Hand-Held Joining Kits and Bench-Mount Joining Machines is aluminum as is structurally prudent. The reason is weight reduction, so that the equipment may be as portable as possible. However, if reasonable care is not taken, some of the equipment, particularly the Heating Anvils (heat face sets), may not prove to be durable. If only the tools to be used are removed from the toolbox supplied with a Hand-Held Kit, or the tool-drawer supplied in a Bench-Mount Machine, and those tools are replaced at the end of the day or the job, their durability will be found quite acceptable. In fact, the Thermal Blanket is supplied with Hand-Held Kits so that the Heat-Tool with Anvils can be wrapped in the Blanket immediately after used and placed in the Toolbox for transport without worry of being burned by the box due to heat transfer. The faithful return of equipment to their places of storage will also minimize lost equipment – just when it is needed – and costly replacement.

If Heating Anvils are minimally dented, and are only in need of replacing the TFE coating, they can be refurbished and re-coated at a standard cost of about three-quarters the as-new cost.

The only replacement part on a Hand-Held Heat-Tool is the thermometer. Other parts cannot be replaced as such. However, the tool may be rebuilt and resold to the owner at a standard cost of about three-quarters of the new cost.

Construction Tips

When a take-off of a mechanical design includes close-coupled flanged fittings or valves, purchase from the Chemtrol factory is strongly encouraged. This work is tedious and the factory has developed special equipment and fixtures for the purpose. This advice would certainly be valid if there is a reducer bushing included between close-coupled flanged fittings or valves. In the case of spigot-end diaphragm valves of PP or Kynar, the joint dimensions are metric size, so that Chemtrol IPS size Heating Anvils are not acceptable for making joints with metric or IPS size fittings or flanges. Again the factory is specially equipped to do this work.

When a reducer bushing is included in a system, we suggest that pipe be fused to the bushing's inside socket first. Then, as the bushing's spigot is fused into a socket connection, the pipe may be grasped for insertion instead of having only the round or hex bushing head to grasp, as would be the case if this step were done first.

Procedures for making good socket fusion joints can be summarized into six basic steps:

- The tool must be operated at the proper temperature.
- The pipe must be beveled.
- The fitting must be slipped squarely onto the male heat face (without squeezing the bead against the end of heat face), while the pipe is simultaneously inserted into the female heat face.
- The fitting and pipe must not remain on the heat faces for an excessive period of time. Recommended heating times must be followed.
- The pipe must be inserted squarely into the fitting socket immediately after removal from the heated faces.
- The heating tool must be kept clean at all times. Wipe away residual material from heat faces with a clean rag. Periodic application of silicone spray to heat faces will assist in maintaining performance.

Flanged Joints

Scope

Flanging is used extensively for process lines that require periodic dismantling. Plastic flanges and factory flanged valves and fittings in PVC, CPVC, PVDF and polypropylene are available in a full range of sizes and types for joining to pipe by solvent welding, threading or socket fusion as in the case with polypropylene and PVDF.

Gasket seals between the flange faces should be an elastomeric full flat faced gasket with a hardness of 50 to 70 durometer A. Chemtrol can provide neoprene gaskets in the 1/2" through 12" range having a 1/8" thickness. For chemical environments too aggressive for neoprene another resistant elastomer should be used. When it is necessary to bolt plastic and metal flanges – use flat face metal flanges – not raised face, and use recommended torques shown in table under "Installation Tips."

Dimensions

Bolt circle and number of bolt holes for the flanges are the same as Class 150 metal flanges per ANSI B16.5. Threads are tapered iron pipe size threads per ANSI B1.20.1. The socket dimensions conform to ASTM D 2467 which describes 1/2" through 8" sizes and ASTM D 439 for Schedule 80 CPVC which gives dimensional data for 1/2" through 6". Internal Chemtrol specifications have been established for the 10" and 12" PVC patterns and 8" CPVC design, as well as socket designs for polypropylene and PVDF.

Pressure Rating

As with all other thermoplastic piping components, the maximum non-shock operating pressure is a function of temperature. Maximum pressure rating for Chemtrol valves, unions and flanges is 150 psi. Above 100° F refer to the chart on page 8.

Sealing

The faces of flanges are tapered back away from the orifice area at a 1/2 to 1 degree pitch so that when the bolts are tightened the faces will be pulled together generating a force in the water way area to improve sealing.

Installation Tips

Once a flange is joined to pipe, the method for joining two flanges together is as follows:

1. Make sure that all the bolt holes of the mating flanges match up. It is not advisable to twist the flange and pipe to achieve this.
2. Use flat washers under bolt heads and nuts.
3. Insert all bolts. (Lubricate bolts.)
4. Make sure that the faces of the flanges mate snugly prior to tightening of the bolts.
5. The bolts on the plastic flanges should be tightened by pulling down the nuts diametrically opposite each other using a torque wrench. (See diagram below) Complete tightening should be accomplished in stages. The final torque values are shown in the table below. Uniform stress across the flange will prevent leaky gaskets.
6. If the flange is mated to a rigid and stationary flanged object, or to a metal flange, the adjacent plastic pipe must be supported or anchored to eliminate excessive stress on the flange joint.

Flange Size	Recommended Torque*
1/2 - 1 1/2"	10 - 15 ft.lbs.
2 - 4"	20 - 30 ft.lbs.
6 - 8"	33 - 50 ft.lbs.
10"	53 - 75 ft.lbs.
12"	80 - 110 ft.lbs.

*For a well lubricated bolt with flat washers under bolt head and nut.

The following tightening pattern is suggested for the flange bolts:

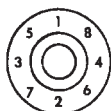

Do not use or test the products in this catalog with compressed air or other gases. See Chemtrol Chem-Aire[®] literature for information about shatter-resistant thermoplastic piping systems specifically designed for compressed air and other gases.

Repairing Thermoplastic Pipe Joints

Scope

The most common method for repairing faulty and leaking joints is hot gas welding at the fillet formed by the fitting socket entrance and the pipe. Fillet welding of thermoplastic is quite similar to the acetylene welding or brazing process used with metals. The fundamental differences are that the plastic rod must always be the same basic material as the pieces to be joined; and heated gas, rather than burning gas, is used to melt the rod and adjacent surfaces.

Welding with plastics involves only surface melting because plastics unlike metals must never be "puddled." Therefore, the resulting weld is not as strong as the parent pipe and fitting material. This being the case, fillet welding as a repair technique is recommended for minor leaks only. It is not recommended as a primary joining technique for pressure rated systems.

Welding Tools and Materials

- Plastic welding gun with pressure regulator, gauge and hose.
- Filler rod
- Emery cloth
- Cotton rags
- Cutting pliers
- Hand grinder (optional)
- Compressed air supply or bottled nitrogen (see Caution next page)
- Source of compressed air

Weld Area Preparation

Wipe all dirt, oil and moisture from the joint area. A very mild solvent may be necessary to remove oil.

CAUTION: Make sure that all liquid has been removed from the portion of the piping system where the weld is to be made.

Welding Faulty Joints

1. Remove residual solvent cement from the weld area using emery cloth. When welding threaded joints, a file can be used to remove threads in the weld area.



2. Wipe the weld area clean of dust, dirt and moisture.



3. Determine the amount of the correct filler rod (see Table, page 30) necessary to make one complete pass around the joint by wrapping the rod around the pipe to be welded. Increase this length enough to allow for handling the rod at the end of pass.



4. Make about a 60° angular cut on the lead end of the filler rod. This will make it easier to initiate melting and will insure fusion of the rod and base material at the beginning of the weld.



5. Welding temperatures vary for different thermoplastic materials (500° F - 550° F for PVC and CPVC, 550° F - 600° F for PP, 575° F - 600° F for PVDF). Welding temperatures can be adjusted for the various thermoplastic materials as well as any desired welding rate, by adjusting the pressure regulator (which controls the gas flow rate) between 3 and 8 psi.

CAUTION: For welding guns which require compressed gas, nitrogen is preferred when the compressed plant air system does not contain adequate drying and filtrations.

Because of its economy, compressed air is normally the gas of choice for most plastic welding. A welding gun which generates its own air supply is frequently desirable for field-made pipe joints where ultimate weld strength is not required. For welding guns which require compressed gas, nitrogen is preferable when the compressed plant air system does not contain adequate drying and filtration. (Presence of moisture in the gas stream causes premature failure in the heater element of the welding gun. Impurities in the gas stream, particularly those in oil, may oxidize the plastic polymer, resulting in loss of strength. Polypropylene is known to be affected in this manner.)

6. With air or inert gas flowing through the welding gun, insert the electrical plug for the heating element into an appropriate electrical socket to facilitate heating of the gas and wait approximately 7 minutes for the welding gas to reach the proper temperature.

CAUTION: The metal barrel of the welding gun houses the heating element so it can attain extremely high temperatures. Avoid contact with the barrel and do not allow it to contact any combustible materials.

Filler rod size and number of weld passes required to make a good plastic weld are dependent upon the size of the pipe to be welded as presented below:

Pipe Sizes	Rod Sizes	Number of Passes
1/2" - 3/4"	3/32"	3
1" - 2"	3/32"	3
2 1/2" - 4"	1/8"	3
6" - 8"	1/8" or 5/32"	5
10" - 12"	5/32" or 3/16"	5

Do not use filler rod larger than 1/8" in diameter when welding CPVC.

7. Place the leading end of the filler rod into the fillet formed by the junction of the pipe and fitting socket entrance. Holding the filler rod at an angle of 90° to the joint for PVC, CPVC and PVDF, 75° to the joint for polypropylene, preheat the surfaces of the rod and base materials at the weld starting point by holding the welding gun steady at approximately 1/4" to 3/4" from the weld starting point and directing the hot gas in this area until the surfaces become tacky. While preheating, move the rod up and down slightly so that the rod lightly touches the base material. When the surfaces become tacky, the rod will stick to the base material.



8. Advance the filler rod forward by applying a slight pressure to the rod. Simultaneously applying even heat to the surfaces of both the filler rod and base material by moving the gun with a fanning or arcing motion at a rate of about 2 cycles per second. The hot gas should be played equally on the rod and base material (along the weld line) for a distance of about 1/4" from the weld point.



9. Since the starting point for a plastic weld is frequently the weakest part of the weld, always terminate a weld by lapping the bead on top of itself for a distance of 3/8" to 1/2". Never terminate a weld by overlapping the bead side by side.

IMPORTANT: If charring of the base or rod material occurs, move the tip of the gun back slightly, increase the fanning frequency or increase the gas flow rate. If the rod or base materials do not melt sufficiently reverse the previously discussed corrective procedures. Do not apply too much pressure to the rod because this will tend to stretch the weld bead causing it to crack and separate after cooling.

10. When welding large diameter pipe, three weld passes may be required (see table to the left). The first bead should be deposited at the bottom of the fillet and subsequent beads should be deposited on each side of the first bead. When making multiple pass welds, the starting points for each bead should be staggered and ample time must be allowed for each weld to cool before proceeding with additional welds.



11. Properly applied plastic welds can be recognized by the presence of small flow lines or waves on both sides of the deposited bead. This indicates that sufficient heat was applied to the surfaces of the rod and base materials to effect adequate melting and that sufficient pressure was applied to the rod to force the rod melt to fuse with base material melt. If insufficient heat is used when welding PVC, CPVC, or PVDF, the filler rod will appear in its original form and can easily be pulled away from the base material. Excessive heat will result in a brown or black discoloration of the weld. In the case of polypropylene, excessive heat will result in a flat bead with oversized flow lines.
12. Always unplug the electrical connection to the heating element and allow the welding gun to cool before shutting off the gas to the gun.

Welding Principles

The procedures for making good thermoplastic welds can be summarized into four basic essentials:

- Correct Heating - Excessive heating will char or overmelt. Insufficient heating will result in incomplete melting.
- Correct Pressure - Excessive pressure can result in stress cracking when the weld cools. Insufficient pressure will result in incomplete fusion of the rod material with the base material.
- Correct Angle - Incorrect rod angle during welding will stretch the rod and the rod material with the base material.
- Correct Speed - Excessive welding speed will stretch the weld bead and the finished weld will crack upon cooling.

Threading Instructions for Thermoplastic Pipe

Scope

The procedure presented herein covers threading of IPS Schedule 80 or heavier thermoplastic pipe. The threads are National Pipe Threads (NPT) which are cut to the dimensions outlined in ANSI B1.20.1 and presented in the table on page 5.

Threading Equipment and Materials

- Pipe Dies
- Pipe Vise
- Threading ratchet or power machine
- Tapered plug
- Cutting lubricant (soap & water)
- Strap wrench
- Teflon tape
- Cutting tools
- Deburring tool

Pipe Preparation

Plastic pipe can be easily cut with a handsaw, power hacksaw, circular or band saw. For best results, use a fine-toothed blade (16-18 teeth per inch) with little or not set (maximum 0.025"). A circumferential speed of about 6,000 ft./min. is suitable for circular saws; band saw speed should be approximately 3,000 ft./min. Carbide-tipped blades are preferable when quantities of pipe are to be cut. To ensure square-end cuts, a miter box, hold-down or jig should be used. Pipe or tubing cutters can be used for smaller diameter pipe when the cutting wheel is specifically designed for plastic pipe. Such a cutter is available from the Reed Manufacturing Co. or Ridge Tool Company.

Threading Dies

Thread cutting dies should be clean, sharp and in good condition, and should not be used to cut materials other than plastics. Dies with a 5° negative front rake are recommended when using power threading equipment and dies with a 5° to 10° negative front rake are recommended when cutting threads by hand. **(NOTE: Special dies for threading plastic pipe are available from Ridge Tool Company.)**

When cutting threads with power threading equipment, self-opening die heads and a slight chamfer to lead the dies will speed production.

Threading and Joining

1. Hold pipe firmly in a pipe vise. Protect the pipe at the point of grip by inserting a rubber sheet or other material between the pipe and vise.
2. A tapered plug must be inserted in the end of the pipe to be threaded. This plug provides additional support and prevents distortion of the pipe in the threaded area. Distortion of the pipe during the threading operation will result in eccentric threads, non-uniform circumferential thread depth or gouging and tearing of the pipe wall. See the following Table for approximate plug O.D. dimensions.

Table: Reinforcing Plug Dimensions*

Pipe Size	Plug O.D.
1/2"	.526
3/4"	.722
1"	.935
1 1/4"	1.254
1 1/2"	1.476
2"	1.913
2 1/2"	2.289
3"	2.864
4"	3.786

*These dimensions are based on the median wall thicknesses and average outside diameter for the respective pipe sizes. Variations in wall thicknesses and O.D. dimensions may require alteration of the plug dimensions.

3. Use a die stock with a proper guide that is free of burrs or sharp edges, so the die will start and go on square to the pipe axis.
4. Push straight down on the handle, avoiding side pressure that might distort the sides of the threads. If power threading equipment is used, the dies should not be driven at high speeds or with heavy pressure. Apply an external lubricant liberally when cutting the threads. Advance the die until the trailing end of the cutting chases approximately pass the end of the pipe.

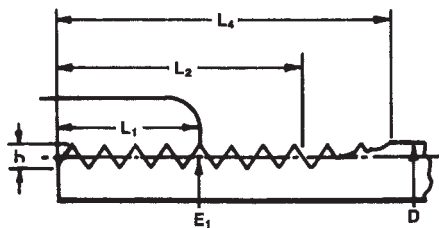

DO NOT THREAD SCHEDULE 40 PIPE

Do not overthread because all threads between the end of the pipe and the trailing end of the chases will be straight and not tapered as indicated in the sketch above. Dimensional detail for National Pipe Threads may be found on page 5.

5. Periodically check the threads with a ring gauge to ensure that proper procedures are being followed. The gauging tolerance is $\pm 1 \frac{1}{2}$ turns and diametrical adjustment to the cutting chases within the die may be required.
6. Brush threads clean of chips and ribbons. Then starting with the second full thread tape in the direction of the threads. Overlap each wrap by one half the width of the tape. NIBCO does not recommend the use of any thread lubricant/sealant other than TFE (Teflon) tape.
7. Thread the fitting onto the pipe and tighten by hand. Using a strap wrench only, further tighten the connection an additional one to two threads past hand tightness. Avoid excessive torque as this may cause thread damage or fitting damage.

Pressure Testing

Threaded piping systems can be pressure tested up to 100% of the hydrostatic pressure rating as soon as the last connection is made.

CAUTION: Air or compressed gas is not recommended and should not be used as a media for pressure testing of plastic piping systems.

Ultraviolet Radiation of Thermoplastic Piping Materials

The presence of Ultraviolet (UV) must at least be considered for every material because of the effect of its radiation of pipe on the medium carried within the pipe depends upon the basic material as well as the pigmentation (colorant) package in the material.

PVC and CPVC

Both materials are attacked by UV radiation, resulting in degradation of the polymeric chains. Embrittlement is the first sign of deterioration, followed by loss of strength and general deterioration of all other physical properties. Industrial CPVC Sch. 80 piping components are traditionally colored light gray while PVC products are dark gray. The coloration for both systems of products is achieved by a blend of Titanium Dioxide (white) and Carbon Black (black). In order to maintain a consistent tone of color, a pigmentation package of approximately 2 1/2 % by weight is required. Through many years of experience it has been shown that the irradiation is blocked by pigment at the surface. B. F. Goodrich conducted one controlled experiment of PVC cooling tower piping on the roof of a motel in Orlando, Florida for over 30 years. Typically, after several years' exposure the gray color, particularly on the pipe top that bears the brunt from the sun, washed out to a lighter gray with white showing through. But when the surface was scratched with the edge of a knife blade the rich dark gray was present, indicating that radiation had not penetrated below the surface. Samples of pipe were taken from the installation at five-year intervals so that coupons could be extracted for physical property testing. After 30 years the testing was stopped with the conclusion that 25 years service could be expected because no statistical difference in results had been noted. The motel was demolished after more than 35 years service. UV protection is not a requirement for gray piping, so painting is not recommended except for cosmetic or color coding reasons.

PVC Sch 40 and SDR water and sewer piping, which are traditionally white in color, may be another story. There is no requirement for the amount of Titanium Dioxide to be included in the plastic compound for white coloration. As a result, minimal amounts of pigment may be present in these very cost competitive high volume products. Also, their time in the inventory supply chain is usually quite short, and the products are frequently buried at installation. With the exception of the highly specialized white piping products intended for furniture, which have a dramatically elevated content of pigment to promote deep color luster, the commercial white piping products should be suspect under long-term direct exposure to sun without some UV protection, painting being one option.

Polypropylene

Polyethylene and PP are rapidly degraded by UV irradiation from sun exposure. For further information on the consequences of the effect of UV radiation and the reasons for Chemtrol offering two complete product lines of pipe, fittings and valves, one black and the other natural (unpigmented), see Materials on page 1.

PVDF (Kynar[®])

The basic PVDF resin is transparent to UV, so it is not degraded by sunlight. For further information on the consequences of the effect of UV radiation and the reasons for Chemtrol offering two complete product lines of pipe, fittings and valves, one red and the other natural (unpigmented), see Materials on page 1.

Painting

Although the slick hard surfaces of the thermoplastic piping systems listed above are not ideal for paint adhesion they may be effectively painted for facilities color coding, cosmetic enhancement or added UV protection. The paint should be a water-based 100% acrylic emulsion system for exterior use. The system will include a primer coat and one topcoat. If the reason for painting is to provide UV protection, white or another light color is the best choice. These contain a greater amount of pigment, principally Titanium Dioxide. Use any brand of high quality house or industrial paint because

these have the higher concentration of pigment and it is the pigment that provides the UV protection. There are two hints, which will greatly contribute to adhesion. First, wash the entire exterior with solvent to clean and degrease it. Axial-grease and caked mud are obvious, but small particles of sand, dust, printing and body oil (fingerprints) are less obvious impurities that require removal. Therefore, do not get the cleaning process too far ahead of painting. Use Methyl Ethyl Ketone (MEK) (available as a plastic pipe cleaner from many distributors of industrial plastic piping) or Isopropyl Alcohol, although more elbow grease will be required with the later. Do not overlook the need for good ventilation when using solvents. Second, insure a continuous film of paint over the entire piping surface. The cohesion of the paint films themselves will help the coating to adhere to the piping. It becomes apparent that painting is not an inexpensive addition to the piping system. However, to specify it correctly the first time will reduce maintenance costs in the long run.

General Underground Installation Procedures for PVC and CPVC Solvent Welded Pipe

The general installation procedures detailed here apply to polyvinyl chloride (PVC) and chlorinated polyvinyl chloride (CPVC) pressure pipe that has solvent welded joints up through 8" in size. These procedures are applicable for all liquids that are conveyed at pressures up to the maximum hydrostatic pressure rating of the pipe or of any component in the piping system, whichever is lowest.

Chemtrol Technical Services should be consulted for installation guidance and recommendation on all sizes of pipe 10" and above and where the installer has had no experience in the installation of PVC or CPVC piping. For additional information, refer to ASTM D 2774, "Underground Installation of Thermoplastic Pressure Piping."

Inspection

Before installation, all lengths of PVC or CPVC pipe and fittings should be thoroughly inspected for cuts, scratches, gouges, buckling, kinking and any other imperfections (such as splits on I.D. or ends of pipe due to impact) which may have been imparted to the pipe during shipping, unloading, storing and stringing. Any pipe or precoupled fittings containing harmful or even questionable defects should be removed by cutting out the damaged section as a complete cylinder.

Trenching

The trench should be of adequate width to allow convenient installation of PVC or CPVC pipe, at the same time being as narrow as possible. The following trench sizes have been used with success. However, actual sizes may vary with terrain and specific application.

Minimum trench widths may be utilized by joining pipe outside of the trench and lowering it into the trench after adequate joint strength has been obtained. Trench widths will have to be wider where the pipe is joined in the trench, or where thermal expansion and contraction is a factor. See section titled "Snaking of Pipe."

Pipe Size	Trench Width	Light Traffic	Heavy Traffic
		Ground Cover	Ground Cover
3" & Under	8"	12" - 18"	24" - 30"
4" & 6"	12"	18" - 24"	30" - 36"
8"	16"	24" - 30"	36" - 42"

The trench bottoms should be continuous, relatively smooth and free of rocks. Where ledge rock, hardpan or boulders are encountered, it is advisable to pad the trench bottom using a minimum of four (4) inches of tamped earth or sand beneath the pipe as a cushion and for protection of the pipe from damage.

Sufficient cover must be maintained to keep external stress levels below acceptable design stress. Reliability and safety of service may assume major importance in determining minimum cover. Local, state and national codes may also govern.

Pipe intended for water service should be buried at least 12" below the maximum expected frost penetration.

Size of Joining Crew

Field practice has shown that the size of the joining crew will depend upon a number of variables, such as, size and length of the pipe, the atmospheric temperature, construction conditions, construction time element, amount of pipe to be layed, construction workers' experience in laying PVC or CPVC pipe, etc. Although it is possible for one man to join the smaller sizes of pipe (2" and under) by himself, it is not necessarily practical to do so. Therefore, the crew sizes presented here are intended as a guide for those PVC or CPVC pipe users who have not had a great deal of experience in the installation of such buried pipe:

1 MAN	Size Pipe 1 1/4" and under. Size Pipe 1 1/2" and 2" maximum 20' lengths.
2 MEN	1 1/2" and 2" where lengths are over 20' or atmospheric temperature is over 90° F. 2 1/2" and 3" pipe in maximum lengths of 20'
3 MEN*	2 1/2" and 3" pipe where lengths are over 20' or atmospheric temperature is over 90° F. 4" through 8" size pipe.
4 MEN**	6" and 8" size pipe where atmospheric temperature is over 90° F.

* Two men do the priming and solvent welding while the third man is positioned at the end of the pipe in order to assist in pushing it into its fully bottomed position in the fitting socket.

** Two men do the priming and apply the cement to the pipe surface while the third man does the same to the fitting socket. The fourth man is positioned at the end of the pipe in order to assist in pushing it into its fully bottomed position in the fitting socket.

NOTE: The need for an extra man when the temperature is above 90° F, is necessary in order to quickly complete the solvent cement application and joining process before rapid evaporation of the cement's solvent causes it to prematurely set.

Solvent Welding

For joining recommendations, see the section titled "Solvent Welding Instructions for PVC and CPVC Pressure Pipe Systems" on page 16.

Snaking of Pipe

After the PVC and CPVC pipe has been solvent welded, it is advisable to snake the pipe beside the trench according to the following recommendation. **BE ESPECIALLY CAREFUL NOT TO APPLY ANY STRESS THAT WILL DISTURB THE UNDRIED JOINT.** This snaking is necessary in order to allow for any anticipated thermal contraction that will take place in the newly joined pipeline.

Pipe Snaking

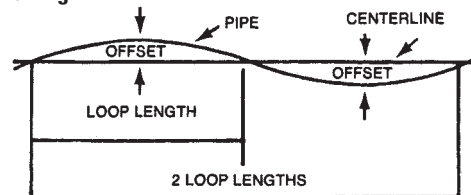

Loop Offset in Inches for Contraction

Loop Length	Maximum Temperature Variation, ° F, Between Time of Solvent and Final Use									
	10°	20°	30°	40°	50°	60°	70°	80°	90°	100°
20 Feet	3"	4"	5"	5"	6"	6"	7"	7"	8"	8"
50 Feet	7"	9"	11"	13"	14"	16"	17"	18"	19"	20"
100 Feet	13"	18"	22"	26"	29"	32"	35"	37"	40"	42"

Snaking is particularly necessary on the lengths that have been solvent welded during the late afternoon of a hot summer's day, because their drying time will extend through the cool of the night when thermal contraction of the pipe could stress the joints to the point of pull out. This snaking is also especially necessary with pipe that is layed in its trench (necessitating wider trenches than recommended) and is back-filled with cool earth before the joints are thoroughly dry.

Bending of Plastic Pipe

Whenever a change of direction is required in a pipeline, it is best accomplished using straight lengths of pipe and factory-made fittings. Bending of pipe leaves residual stresses and consequently bending is not recommended as a normal practice, particularly if the line is intended to operate at or near maximum temperatures and/or pressure.

If field bending is required to meet special conditions the following techniques should be employed to give the best pressure carrying capability of the installed system.

1. **Heating Media:** The heating media may be hot air in a circulating oven operating at approximately 360° F. The heating media may also be radiant heat in which case the pipe surface in the area of the bend or the pipe may be immersed in hot oil. An open flame should never be used. Heating times will range from approximately one to five minutes or until it becomes soft and pliable to bend, depending upon pipe size and type of heat source.
2. To maintain the cross sectional area of the I.D. of the pipe in the area of the bend, it must be supported during the bending operations.

There are three suggested methods for supporting the pipe.

- a. The I.D. can be supported by filling with preheated sand and plugging both ends.
 - b. A heated reinforcing spring can be placed inside of the pipe after it has been heated to a soft, pliable condition. The spring should be made with 3/32" diameter wire and the O.D. of the spring should be slightly less than the nominal I.D. of the pipe to be bent. Springs can be custom made by any local spring manufacturer.
 - c. When the pipe becomes soft and pliable it can be placed in forming jig or form and bent as quickly as possible to prevent weakening or deforming of the pipe.
3. The minimum radius to which a bend should be made, measured from the inner edge of the curve, should be 8 pipe diameter for 3/4" pipe size and below and 6 pipe diameters for larger pipe. The initial forming bend will have to be slightly greater to allow for spring back.
 4. The bend should be kept in the bent form until the pipe cools and becomes rigid enough to be handled without deforming. It should then be immediately immersed in water to complete the cooling process. The sand or spring should not be removed until final cooling is completed.

When plastic pipe is heated and then bent, it will shrink with the degree of shrinkage depending on the size of the pipe and the radius of the bend. Therefore, the pipe should be cut to lengths slightly greater than the total length of the bend and the tangents.

5. A straight section of at least two pipe diameters should be left at either side of the bend to insure a round, low stress section with which to make joints.

NOTE: Highly crystalline thermoplastics such as PVDF should never be formed in this way due to the potential detrimental effect of the process on the molecular structure and properties of the material.

The above discussion covers only the basics involved with bending plastic pipe. Experience and some trial-and-error will be required to develop an expertise in bending pipe. Contact the pipe manufacturer with further questions.

Cleaning

Even though care should be exercised at all times to prevent the entry of dirt, water, and other foreign material into the PVC or CPVC pipe fittings, it is advisable that the pipeline be thoroughly cleaned before working pressure is applied.

Testing

See section titled "Solvent Welding Instructions for PVC and CPVC Pressure Pipe Systems," page 16.

Backfilling

Ideally, backfilling should only be done early in the morning during hot weather when the line is fully contracted and there is no chance of insufficiently dried joints being subject to contraction stresses.

The pipe should be uniformly and continuously supported over its entire length on firm, stable material. Blocking should not be used to change pipe grade or to intermittently support pipe across excavated sections.

Pipe is installed in a wide range of sub-soils. These soils should not only be stable but applied in such a manner so as to physically shield the pipe from damage. Attention should be given to local pipe laying experience which may indicate particular pipe bedding problems.

Backfill materials free of rocks with a particle size of 1/2" or less should be used to surround the pipe with 6" to 8" of cover. It should be placed in layers.

Each solid layer should be sufficiently compacted to uniformly develop lateral passive soil forces during the backfill operation. It may be advisable to have the pipe under pressure, 15 to 25 psi during the backfilling.

Effects of ground freezing should be considered when pipe is installed at depths subject to frost penetration.

Vibratory methods are preferred when compacting sand or gravels. Best results are obtained when the soils are in nearly saturated condition. Where water flooding is used, the initial backfill should be sufficient to insure complete coverage of the pipe. Additional material should not be added until the water flooded backfill is firm enough to walk on. Care should be taken to avoid floating the pipe.

Sand and gravel containing a significant proportion of fine-grained material, such as silt and clay, should be compacted by hand or, preferably by mechanical tamper.

The remainder of the backfill should be placed and spread in approximately uniform layers in such a manner to fill the trench completely so that there will be no unfilled spaces under or about rocks or lumps of earth in the backfill. Large or sharp rocks, frozen clods and other debris greater than 3" in diameter should be removed. Rolling equipment or heavy tampers should only be used to consolidate the final backfill.

Additional information on underground installation is given in ASTM D 2321 "Underground Installation of Flexible Thermoplastic Pressure Piping."

Connecting Pipe Sections

Sections of PVC or CPVC pipe that have been backfilled or plowed in during the heat of the day should be sufficiently overlapped to allow for contraction and not joined up to one another or any stable connection or fitting until the morning following their night of cooling and thermal contraction. See the section "Expansion and Contraction of Plastic Pipe" page 12 for calculating anticipated contraction.

Pipe Locating

The location of all PVC and CPVC pipelines should be accurately and precisely recorded. Conductive wire can be trenched or plowed in with the pipe as an aid for future locating purposes.

Below Grade Valves, Anchors or other Connections

As a rule of thumb in designing and installing a PVC or CPVC underground piping system, it is pointed out that pipe made from these materials is not designed to be used for any structural applications beyond withstanding normal soil loads and internal pressures up to its hydrostatic pressure rating.

Anchors, valve boxes, etc. must be independently supported so as to not introduce additional bending or sheer stress on the pipe.

Roadways and Railroad Tracks

It is recommended that plastic pipe be run within a metal or concrete casing when it is installed beneath surfaces that are subject to heavyweight or constant traffic; such as roadways, railroad tracks, etc.

Concrete Anchors

Concrete anchors can be poured around PVC or CPVC pipe at direction changes. If the purpose for anchoring is to restrain axial movement of the pipe, this can be done by solvent welding split collars around the pipe O.D. to provide a shoulder against the concrete wall. Solvent welded surface between collar and pipe O.D. must dry 48 hours prior to pouring of concrete.

Risers

Although PVC or CPVC pipe has excellent weathering resistance, it should not be brought above grade under the following circumstances:

1. If it is expected to provide structural strength, such as supporting an above-grade metal valve. The metal valve should be installed with an independent support.
2. If it is subject to external damage. This could be remedied by sleeving the pipe with an independently and rigidly supported steel pipe.
3. If it is subject to high temperature environments; i.e. summer sun that could lower the pipe's pressure rating below an acceptable level. Such a situation might be remedied by insulating the PVC or CPVC pipe.

Product Line

Chemtrol® offers a premium line of quality valves, fittings, and pipe for all of your flow-control applications.

Polyvinyl Chloride (PVC)



Chlorinated Polyvinyl Chloride (Corzan® CPVC)



Typical Applications		Chemical processing, industrial plating, chilled water distribution, chemical drainage, and irrigation systems	Systems for hot corrosive liquids, hot and cold water distribution, chemical processing, industrial plating, deionized water lines, chemical drainage, waste water treatment systems, and similar applications above the temperature range of PVC
Joining Methods		Solvent cementing, threading, or flanging	Solvent cementing, threading, or flanging
Max. Service Temperature		140° F/60° C	210° F/99° C
Fittings	Schedule 80	Socket– 1/2" through 12" Threaded– 1/4" through 4"	Socket– 1/4" through 12" Threaded– 1/4" through 4", Van Stone flanges
	Large diameter	Schedules 40 and 80 10" and 12" couplings, tees, 90° and 45° elbows, reducer bushings, and Van Stone flanges	10" and 12" couplings, tees, 90° and 45° elbows, reducer bushings
Valves	Tru-Bloc/True Union ball valves*	1/2" through 6" socket, threaded, and flanged connections	1/2" through 6" socket, threaded, and flanged connections
	Tru-Bloc/True Union ball check valves	1/2" through 4" with socket, threaded, or flanged ends	1/2" through 4" with socket, threaded, or flanged ends
	Butterfly valves*	EPDM and FPM (Viton®) liner	EPDM and FPM (Viton®) liner 3" only
	Diaphragm valves	1/2" through 4" with spigot, socket, or flanged ends	1/2" through 4" with spigot, socket, or flanged ends. Also available in PVC, natural polypropylene (Chem-Pure®) and natural PVDF
	Multiport valves*	True Union 3-way/3-position; 1/2" through 2" with socket, threaded, or flanged ends	True Union 3-way/3-position multiport ball valves, 1/2" through 2" with socket and threaded ends
	Specialty valves	Angle and Y pattern: 1/4" through 1" threaded Needle and Chemcock: 1/4" threaded	
Pipe			

*For pneumatic or electric actuation.

Refer to Chemtrol Technical Manuals for pressure ratings at various temperatures.

Polypropylene (PP)		Polyvinylidene Fluoride (KYNAR [®] PVDF)		Chem-Aire [®] Compressed Air Systems
				
Black Polypropylene: Clean chemical processes, hot corrosive liquids, industrial plating, waste treatment systems	Natural Polypropylene: Deionized water systems, clean chemical processes, pharmaceutical operations, food processing	Red KYNAR[®] PVDF, which protects fluid medium from UV exposure, is an excellent material for general industrial applications, especially outdoor installations.	Natural KYNAR[®] (Unpigmented) PVDF is ideal for industries such as electronics, pharmaceuticals, and processed foods or beverages.	Chem-Aire [®] is a homogeneous, shatter-resistant thermoplastic piping system specifically designed for compressed air. Manufactured from a specially engineered formulation of acrylonitrile butadiene styrene (ABS), it offers outstanding strength, ductility, and impact resistance.
Thermo-seal fusion, threading, or flanging	Thermo-seal fusion, threading, or flanging	Socket heat fusion, threading, or flanging	Socket heat fusion, threading, or flanging	Solvent cementing or TruConnect [™] "push-to-connect" fittings
180° F/82° C	180° F/82° C	280° F/138° C	280° F/138° C	140° F/60° C (1/2" through 2"); 120° F/50° C (3" through 4") 185 psi@100° F
IPS socket type—1/2" through 6" Threaded—1/2" through 4"	IPS socket type—1/2" through 4" Threaded—1/2" through 4"	IPS socket type—1/2" through 6" Threaded—1/2" through 2"	IPS socket type—1/2" through 6" Threaded—1/2" through 2"	TruConnect [™] "push-to-connect" fittings—1/2" through 2" Socket—1/2" through 4"
1/2" through 4" with socket, threaded, or flanged ends	1/2" through 4" with socket, threaded, or flanged ends	1/2" through 4" with socket, threaded, or flanged ends	1/2" through 4" with socket, threaded, or flanged ends	Tru-Bloc [®] /True Union Safety Vent [®] ball valves* 1/2" through 4" with socket ends 1/2" through 2" TruConnect [™] "push-to-connect" ends
1/2" through 4" with socket, threaded, or flanged ends		1/2" through 4" with socket, threaded, or flanged ends	1/2" through 4" with socket, threaded, or flanged ends	
	1/2" through 4" with metric spigot, IPS socket, or ANSI flanged ends.		1/2" through 4" with metric spigot, IPS socket, or ANSI flanged ends.	
NIBCO socket fusion equipment for joining PP and KYNAR [®] (PVDF) fittings 1/2" through 6"				
Schedule 40 and 80 wall thicknesses		Schedule 40 and 80 wall thicknesses		IPS diameters with heavy-duty wall thickness: SDR 9.0 (1/2" - 2") and SDR 10.0 (3" - 4")

Polyvinyl Chloride (PVC) Schedule 80 Industrial Pipe and Fittings

Scope:

This specification establishes the manufacturing requirements for PVC Schedule 80 piping components intended for use in industrial, pressure-rated, fluid-handling systems for applications at 140° F or less, where resistance to corrosion is of prime importance.

Materials:

Pipe and fittings shall be manufactured from a PVC compound that meets the requirements of Cell Classification 12454 polyvinyl chloride as outlined in ASTM D1784. PVC shall be gray in color. Pipe and fitting materials shall be specifically formulated with sufficient UV stabilizers to provide for long-term outdoor exposure with no deleterious effects.

Materials from which pipe and fittings are manufactured shall have been tested and approved for conveying potable water by NSF International.

Dimensions/Design (IPS Size):

Socket-end connections shall have diameters, lengths, and wall thicknesses as required by ASTM D 2467; taper pipe threaded-end connections shall have thread lengths, diameters, and configurations in conformance with ASTM D 2467.

Fittings shall be industrial, heavy-duty, hub style.

Flanges shall be either a one-piece solid or a two-piece Van Stone design that utilizes the tapered, serrated-face and full-face gasket technique for joining and are compatible with ASME B16.5 Class 150 metal flanges.

Unions shall have an O-ring seal and components interchangeable with true union valves for maximum system versatility.

Transition unions, unions intended for joining dissimilar materials, shall utilize components of the two dissimilar materials, joined with an O-ring to absorb the thermal-expansion coefficient differential.

Pipe shall be as prescribed by ASTM D 1785 for pressure-rated piping systems.

Pressure Ratings:

Socket fittings shall be rated at the same pressure as the corresponding size pipe prescribed by ASTM D 1785. Threaded fittings shall be rated at 50% of the pressure rating of the corresponding size pipe prescribed by ASTM D 1785.

Valves, unions, and flanges shall be rated at 150 psi for non-shock water service at 73° F and have a minimum burst requirement of 3.3 times the rated pressure.

Markings:

Fittings and pipe shall be clearly marked with the manufacturer's name or trademark, material designation, ASTM number or equivalent symbol indicating compliance with applicable standards, NSF International certification mark, NSF-pw, (verifying approval for the conveyance of potable water), and the country of manufacture.

Installation/Maintenance:

At the specifying engineer's option, the manufacturer shall provide, at no additional cost, on-site training for installation/maintenance personnel. Otherwise, installation shall be as specified by the manufacturer's printed instructions.

Chlorinated Polyvinyl Chloride (CPVC) Schedule 80 Industrial Pipe and Fittings

Scope:

This specification establishes the manufacturing requirements for CPVC Schedule 80 piping components intended for use in industrial, pressure-rated, fluid-handling systems for applications at 210° F or less, where resistance to corrosion at elevated temperatures is of prime importance.

Materials:

Rigid CPVC (chlorinated polyvinyl chloride) used in the manufacture of Schedule 80 piping components shall be Cell Classification 23447 as identified in ASTM D 1784. CPVC materials shall be light gray in color. Pipe and fitting materials shall be specifically formulated with sufficient UV stabilizers to provide for long-term outdoor exposure with no deleterious effects. CPVC material used to manufacture pipe and fittings shall be approved for the conveyance of potable water by a third-party certification agency.

Dimensions/Design (IPS Size):

Socket-end connections shall have diameters, lengths, and wall thicknesses as required by ASTM F 439; taper pipe threaded-end connections shall have thread lengths, diameters, and configurations in conformance with ASTM F 437.

Pipe shall have diameters and wall thicknesses in conformance with the requirements of ASTM F 441.

Fittings shall be industrial, heavy-duty, hub style.

Flanges shall be either a one-piece design or a two-piece Van Stone design that utilizes the tapered, serrated-face and full-face gasket technique for joining and are compatible with ASME B16.5 Class 150 metal flanges.

Unions shall have an O-ring seal and components interchangeable with true union valves for maximum system versatility.

Transition unions, unions intended for joining dissimilar materials, shall utilize components of the two dissimilar materials, joined with an elastomeric seal to absorb the thermal-expansion coefficient differential.

Pressure Ratings:

Socket fittings shall be rated at the same pressure as the corresponding size pipe prescribed by ASTM F 441. Threaded fittings shall be rated at 50% of the pressure rating as the corresponding size pipe prescribed by ASTM F 441.

Valves, unions, and flanges shall be rated at 150 psi for non-shock water service at 73° F, and have a minimum burst requirement of 3.3 times the rated pressure.

Markings:

Fittings and pipe shall be clearly marked with the manufacturer's name or trademark, material designation, ASTM number or equivalent symbol indicating compliance with applicable standards, NSF International certification mark, NSF-pw, (verifying approval for the conveyance of potable water), and the country of manufacture.

Installation/Maintenance:

At the specifying engineer's option, the manufacturer shall provide, at no additional cost, on-site training for installation/maintenance personnel. Otherwise, installation shall be as specified by the manufacturer's printed instructions.

Polypropylene (PP) Schedule 80 Industrial Pipe and Fittings

Scope:

This specification establishes the manufacturing requirements for black and Chem-Pure® Schedule 80 polypropylene piping components intended for use in industrial, pressure-rated, fluid-handling systems for applications at 180° F or less, where resistance to corrosion are of prime importance.

Materials:

Rigid PP (polypropylene) used in the manufacture of Schedule 80 piping components shall be one of the following:

Black Polypropylene:

- Pipe-material shall be Cell Class PP0110-A2-1510 as per ASTM D 4101. Fittings material shall be Cell Class PP0110-M30-A10120 (glass bead material) and Cell Class PP0110-B67154 (unfilled material) as per ASTM D 4101. These materials shall be pigmented jet black.

Chem-Pure (Natural) Polypropylene:

- Pipe material shall be Cell Class PP0110-A2-1510 as per ASTM D 4101. Fitting material shall be Cell Class PP0210-B45145 as per ASTM D 4101. These materials shall be unpigmented.

Dimensions/Design (IPS Size):

Socket-end connections suitable for heat-fusion welding shall have socket lengths and wall thicknesses as required for Schedule 80 fittings in ASTM D 2467. Socket diameters shall be in accordance with the manufacturer's recommendations for an interference fit with the pipe as prescribed in ASTM D 2657; taper pipe threaded-ends shall have lengths, diameters, and configuration in accordance with ASTM D 2467 for Schedule 80 fittings.

Pipe shall have diameters and wall thicknesses in conformance with ASTM D 1785 for Schedule 80 pipe.

Fittings shall be industrial, heavy-duty, hub style.

Flanges shall be one-piece design utilizing the tapered-, serrated-, and full-face gasket technique for joining, with bolt pattern compatible with ASME B16.5 Class 150 metal flanges.

Unions shall have an O-ring seal and components interchangeable with true union valves for maximum system versatility.

Transition unions, unions intended for joining dissimilar materials, shall utilize components of the two dissimilar materials, joined with an elastomeric seal to absorb the thermal-expansion coefficient differential.

Pressure Ratings:

Pipe and fittings joined by the heat-fusion technique shall be rated according to the following pressures for a given nominal size at 73° F water service.

½ – 410 psi	1 – 310 psi	2 – 200 psi	4 – 160 psi
¾ – 330 psi	1-1/2 – 230 psi	3 – 190 psi	6 – 140 psi

NOTE: Threaded pipe and fittings shall be rated at 20 psi maximum for all sizes at 73° water service.

Heat-fusion valves, unions, and flanges shall be rated at 150 psi for non-shock water service at 73° F and have a minimum burst requirement of 3.3 times the rated pressure.

Markings:

Fittings and pipe shall be clearly marked with the manufacturer's name or trademark, nominal size, material designation, and country of manufacture.

Installation/Maintenance:

At the specifying engineer's option, the manufacturer shall provide, at no additional cost, on-site training for installation/maintenance personnel. Otherwise, installation shall be as specified by the manufacturer's printed instructions. Specialized joining equipment shall be as recommended by the manufacturer.

Polyvinylidene Fluoride (PVDF) (KYNAR®) Schedule 80 Industrial Pipe and Fittings

Scope:

This specification establishes the manufacturing requirements for red and natural PVDF Schedule 80 piping components intended for use in industrial, pressure-rated, fluid-handling systems of 280° F or less where resistance to corrosion are of prime importance.

Materials:

Rigid PVDF (polyvinylidene fluoride) used in the manufacture of Schedule 80 piping components shall conform to requirements in ASTM D 3222 for Type I homopolymers. Pipe and fitting components shall be manufactured from one of the following:

Red Kynar®:

PVDF compound with a minimum of 1.7% red pigment content for opaqueness to UV radiation.

Natural Kynar®:

Unpigmented 700 series PVDF compound of the highest purity and maximum transparency to UV radiation.

Dimensions/Design:

Socket-end connections suitable for heat-fusion welding shall have socket lengths and wall thicknesses conforming to ASTM D 2467 and socket diameters shall be in accordance with the manufacturer's printed recommendations to provide an interference-fit with the pipe; taper pipe threaded-ends shall have thread lengths, diameters, and configurations in conformance with ASTM D 2467.

Pipe shall be manufactured to the same tolerances for outside diameter and wall thicknesses as outlined in ASTM D 1785 for Schedule 80 pipe.

Fittings shall be industrial, heavy-duty, hub style.

Unions shall have an O-ring seal and components interchangeable with true union valves for maximum system versatility.

Transition unions, unions intended for joining dissimilar materials, shall utilize components of the two dissimilar materials, joined with an elastomeric seal to absorb the thermal-expansion coefficient differential.

Pressure Ratings:

Pipe and fittings joined by the heat-fusion technique shall be rated according to the following pressures for a given nominal size at 73° F water service.

½ – 580 psi	1 – 430 psi	2 – 270 psi	4 – 220 psi
¾ – 470 psi	1-1/2 – 320 psi	3 – 260 psi	6 – 190 psi

NOTE: Threaded pipe and fittings shall be rated at 50% of the values given for socket ends.

Valves, unions, and flanges (either socket or threaded end) shall be pressure rated at 150 psi non-shock water service at 73° F and have a minimum burst requirement of 3.3 times the rated pressure.

Markings:

All pipe, fittings, and valves shall be clearly marked with the manufacturer's name or trademark, nominal size, and country of manufacture.

Installation:

At the specifying engineer's option, the manufacturer shall provide, at no additional cost, on-site training for installation/maintenance personnel. Otherwise, installation shall be as specified by the manufacturer's printed instructions. Specialized joining equipment shall be as recommended by the pipe, valves, and fittings manufacturer.

150 PSI Tru-Bloc, True Union Ball Valves 1/2" through 6" Nominal Sizes

Scope:

This specification establishes the manufacturing requirements for dual-blocking (Tru-Bloc) and downstream-only blocking (true union) quarter-turn ball valves of PVC, CPVC, PP, and PVDF materials intended for use in industrial, commercial, and residential pressure-piping systems, where cost-effective, long-term resistance to corrosion is of prime importance, and the service temperature does not exceed: PVC, 140° F; CPVC, 210° F; PP, 180° F; PVDF, 280° F.

Major component parts shall be constructed from one of the following:

NPS ½ – 6 PVC (polyvinyl chloride), Cell Class 12454 per ASTM D 1784, industrial gray in color, and the valve style shall be full-port Tru-Bloc, TU (NPS 6 is standard port) or Tru-Bloc, SU (NPS 1/2 – 2 only).

NPS ½ – 6 CPVC (chlorinated polyvinyl chloride), Cell Class 23447 per ASTM D 1784, industrial light gray in color, and the valve style shall be full-port Tru-Bloc, TU (NPS 6 is standard port) or Tru-Bloc, SU (NPS 1/2 – 2 only).

NPS ½ – 4 PP (polypropylene) Cell Class PP0110-M30-A10120 (glass-filled material) and Cell Class PP0110-B67157 (unfilled material) as per ASTM D 4101. These materials shall be pigmented jet black. Valve style shall be full-port True Union.

NPS ½ – 4 Chem-Pure[®] (natural polypropylene) Cell Class PP0210-B45145 as per ASTM D 4101. Materials shall be unpigmented and of the highest purity. Valve style shall be full-port True Union.

NPS ½ – 4 PVDF (polyvinylidene fluoride) Type I compound per ASTM D 3222. The material shall be red Kynar[®] (pigmented red) for maximum UV opacity, and the valve style shall be full-port Tru-Bloc, TU or True Union.

NPS ½ – 4 PVDF (polyvinylidene fluoride) Type I compound per ASTM D 3222. The material shall be natural (unpigmented) 700 Series Kynar[®] of the highest purity and maximum transparency to UV radiation, and the valve style shall be full-port Tru-Bloc, TU or True Union.

Dimensions/Valve Design:

PVC and CPVC socket-end connections shall conform to the requirements of ASTM D 2467 and F 439 for Schedule 80 pressure fittings, PP and PVDF socket-end connections shall be suitable for heat-fusion welding as specified in ASTM D 2567 Technique I.

All threaded-end connections shall conform to the requirements of ASTM D 2467 and F 439 as well as ASTM F 1498 for tapered pipe threads.

Performance:

Valves shall be rated for 150 psi non-shock water service at 73° F water and have a minimum burst rating of 3.3 times the rated working pressure.

Valves shall be certified to ASTM F 1970 by a third-party agency.

Markings:

Valves shall be clearly marked with the manufacturer's name or trademark, nominal size, material designation, ASTM number or equivalent symbol indicating compliance with applicable standards, and country of manufacture. PVC and CPVC valves shall additionally bear the NSF International certification mark, NSF-pw, (verifying approval for conveyance of potable water).

Installation:

At the specifying engineer's option, the manufacturer shall provide, at no additional cost, on-site training for installation/maintenance personnel. Otherwise, installation shall be as specified by the manufacturer's printed instructions.

PVC and CPVC Bleach Ball Valves True Union Model-C

Recommended Specification

In the interest of safety, owners of sodium hypochlorite transfer and injection piping systems must have confidence that the PVC or CPVC ball valves in their system were properly manufactured, cleaned, assembled, tested, and oriented during installation in accordance with intended system design. Therefore, engineering specifications for bleach transfer and injection systems should include the following product, installation, and pre-commissioning inspection requirements:

- All PVC or CPVC bleach ball valves must be of the True Union type *with an energized seat* that will concurrently provide automatic adjustment for wear and leak-free service at the lower pressure port. And *the ball must contain an adequate vent* to the pressure port opposite of the downstream sealing port.
- The manufacturer of all PVC or CPVC bleach ball valves must *complete all components prior to the factory assembly, test, and packaging of those valves*. Modification of assembled valves by any manufacturer or vendor is unacceptable. Also, the valves must be individually packaged with each carton label stating: *Bleach ball valve, size, material, and manufacturer*.
- Bleach ball valves must be *permanently marked externally* with: the word *Bleach*; *two opposing directional arrows*, one inscribed with *Flow* and other with *Vent*; and *NSF* (symbol of the National Sanitation Foundation International, indicating approval for use with potable water).

150 PSI Ball Check and Foot Valves PVC, CPVC, PP, PVDF 1/2" through 4" Nominal Sizes

Scope:

This specification establishes the manufacturing requirements for PVC, CPVC, PP, and PVDF ball check and PVC, CPVC foot valves intended for use in industrial, commercial, and residential pressure-piping systems, where cost-effective, long-term resistance to corrosion is of prime importance. Maximum service temperatures are: PVC, 140° F; CPVC, 210° F; PP, 180° F; PVDF, 280° F.

Materials:

Major component parts shall be constructed from one of the following:

NPS ½ – 4 PVC (polyvinyl chloride), Cell Class 12454 per ASTM D 1784, industrial gray in color.

NPS ½ – 4 CPVC (chlorinated polyvinyl chloride), Cell Class 23447 per ASTM D 1784, industrial light gray in color.

NPS ½ – 2 PP (polypropylene) Cell Class PP0110-M30-A10120 (glass-filled material) and Cell Class PP0110-B67157 (unfilled material) as per ASTM D 4101. These materials shall be pigmented jet black.

NPS 1-1/2 – 2 Chem-Pure[®] (natural polypropylene) Cell Class PP0210-B45145 as per ASTM D 4101. Materials shall be unpigmented and of the highest purity.

NPS ½ – 2 PVDF (polyvinylidene fluoride) Type I compound per ASTM D 3222. The material shall be pigmented red for maximum UV opaqueness.

NPS ½ – 2 PVDF (polyvinylidene fluoride) Type I compound per ASTM D3222. The material shall be natural (unpigmented) 700 Series Kynar[®] of the highest purity and maximum transparency to UV radiation.

Dimensions/Valve Design:

PVC and CPVC socket-end connections shall conform to the requirements of ASTM D 2467 and F 439 for Schedule 80 pressure fittings. PP and PVDF socket-end connections shall be suitable for heat-fusion welding as specified in ASTM D 2567 Technique I. All threaded-end connections shall conform to the requirements of ASTM D 2467 and F 439 as well as ASTM F 1498 for tapered pipe threads.

The valve design shall be full port (NPS 6 size is standard port) with full flow around the rib-guided ball. Foot valve models shall have a minimum cumulative-area ratio of screen holes (inlet)-to-valve port of 3:1.

The valve seat shall be an elastomeric seal that will permit seating at low-head pressure, and an arrow shall be molded on the valve body for permanent visibility to indicate the intended direction of flow.

Markings:

Valves shall be clearly marked with the manufacturer's name or trademark, nominal size, material designation, ASTM number or equivalent symbol indicating compliance with applicable standards, and country of manufacture. PVC and CPVC valves shall additionally bear the NSF International certification mark NSF-pw, (verifying approval for conveyance of potable water).

Performance:

Valves shall be rated for 150 psi service at 73° F non-shock water service and have a minimum burst rating of 3.3 times the rated working pressure. Valves shall be certified to ASTM F 1970 by a third-party agency.

Installation:

At the specifying engineer's option, the manufacturer shall provide, at no additional cost, on-site training for installation/maintenance personnel. Otherwise, installation shall be as specified by the manufacturer's printed instructions.

150 PSI Model "B" Wafer Style Butterfly Valves PVC or CPVC 3", 4", 6" Nominal Sizes

Scope:

This specification establishes the manufacturing requirements for PVC and CPVC, Butterfly Valves intended for use in industrial, commercial, and residential pressure-piping systems for service temperatures that do not exceed 140° F for PVC systems or 210° F for CPVC systems, where resistance to corrosion is of prime importance does not.

Materials (PVC NPS 4 & 6, CPVC 3):

The body and disc shall be manufactured from a PVC or CPVC compound that meets the requirements of Cell Class 12454 polyvinyl chloride or Cell Class 23447 chlorinated polyvinyl chloride as outlined in ASTM D 1784.

The shaft shall be cadmium-plated steel alloy or 316 stainless steel as standard equipment. Optional shaft materials shall be available on request, i.e., titanium, stainless steel, etc.

The seat material shall be one of the following materials: ethylene-propylene-diene monomer (EPDM) or fluoroelastomer (FPM) with polytetrafluoroethylene (PTFE) bearing support at the top and bottom.

Bearings shall be corrosion-resistant, 20% glass-filled PTFE.

Secondary seal material shall be FPM or EPDM and correspond to the seat material for maximum chemical resistance.

Handles and worm-gear operators shall be of a contrasting color with corrosion-resistant epoxy coating per manufacturer's Engineering Specifications #AP00307002A.

Valve Design:

The valve body shall be of the wafer design for ease of installation and maintenance and shall be compatible with Class 150 ASME B16.5 flanges. Nominal sizes 3 through 6 shall also be compatible with DIN 8063 pattern.

The shaft shall be hexagonal or square to ensure positive rotation of the disc and be totally sealed from exposure to the process liquid.

The shaft shall be guided by glass-filled TFE bearings to protect against deflection. The shaft also shall have a directional indicator on top to indicate disc position when the handle is removed.

Markings:

Valves shall be clearly marked with the manufacturer's name or trademark, nominal size, material designation, and country of manufacture. PVC and CPVC valves shall additionally bear the NSF International certification mark, NSF-pw, (verifying approval for conveyance of potable water).

Performance:

Valves shall be rated bubble-tight at 150 psi 73° F non-shock water service except NPS 6 size shall be de-rated by 25%. The pressure rating shall be based on a minimum safety factor of 3.3.

Operation:

Valves shall be supplied by the manufacturer with one of the following:

a. Lever handle with index plate	e. 2" Square Operator Nut
b. Worm-Gear Operator	f. 2" Locking Type Square Operator Nut
c. Pneumatic Operator	g. Lockable Lever Handle
d. Electric Operator	h. Other Manual Accessories

Installation:

At the specifying engineer's option, the manufacturer shall provide, at no additional cost, on-site training for installation/maintenance personnel. Otherwise, installation shall be as specified by the manufacturer's printed instructions.

150 PSI Model "C" Wafer Style Butterfly Valves PVC 2" through 10" Nominal Sizes

Scope:

This specification establishes the manufacturing requirements for PVC Butterfly Valves intended for use in industrial, commercial, and residential pressure-piping systems for non-corrosive or mildly corrosive applications, where the service temperature does not exceed 140° F.

Materials:

The body shall be manufactured from a PVC compound that meets the requirements of Cell Class 12454 polyvinyl chloride as outlined in ASTM D 1784.

The disc shall be manufactured of ductile iron as specified in ASTM A 395 with EPDM encapsulation.

The upper and lower shaft shall be manufactured from 416 stainless steel as specified in ASTM A 582.

The O-ring seal material shall be manufactured from EPDM.

The bearing shall be manufactured from PTFE-coated bronze centered on steel.

The handle is of malleable iron with epoxy coating. The throttling index plates are made of zinc-plated steel.

Valve Design:

Valve body shall be of the wafer design for ease on installation and maintenance and shall be compatible with bolt hole pattern Class 150 ASME B16.5; BS 1560 class 150; DN 200 ISO 2084 PN 10; and DN 200 DIN 2532 PN 10.

The shaft is splined to lock into the disc to ensure positive rotation. The shaft is guided by teflon-coated bearings to protect against deflection. Disc position is indicated by the shaft, when the handle is removed.

Laying length is compatible with MSS SP-67 narrow (W-1) and DN 200 ISO 5752 short.

Markings:

Valves shall be clearly marked with the manufacturer's name or trademark, nominal size, material designation, ASTM number or equivalent symbol indicating compliance with applicable standards, country of origin, and pressure rating. Valves additionally bear the NSF International certification seal, NSF-pw, (verifying approval for the conveyance of water).

Performance:

Valves shall be rated bubble-tight at 150 psi 73° F non-shock water service. The pressure rating shall be based on a minimum safety factor of 3.3. Valves shall be certified to ASTM F 1970 by a third-party agency.

Installation:

At the specifying engineer's option, the manufacturer shall provide, at no additional cost, on-site training for installation/maintenance personnel. Otherwise, installation shall be as specified by the manufacturer's printed instructions.

Y-Pattern – Chemcock – Calibrated Needle 1/4" through 1" Nominal Sizes

Scope:

This specification establishes the manufacturing requirements for PVC Schedule 80 specialty valves for use in industrial, pressure-rated, fluid-handling systems in applications up to 140° F, where precise control and corrosion resistance are of prime importance.

Materials:

Rigid PVC (polyvinyl chloride) used in the manufacture of Schedule 80 valves shall be Cell Classification 12454 as identified in ASTM D 1784.

Dimensions/Valve Design:

Valves utilizing threaded-end connections shall have thread lengths, diameters, and configurations as required by ASTM D-2467 and ASTM F 1498.

Hose-barb connections (Chemcock Valve) shall be suitable for joining with ¼" to 3/8" I.D. measured flexible hose.

Valves intended for multi-turn throttling control shall be globe design in NPS ¼ – 1.

Y-Pattern for straight 180° installations using internal pipe threads and having double lead-thread stem control for rapid adjustment. Valves shall have glass-filled PTFE seals for positive shut-off and extended service-life and FPM seals for maximum protection against external leaks.

Angle valve for 90° installations using internal pipe threads and having double lead-thread stem control for rapid adjustment. Valves shall have glass-filled PTFE seals for positive shut-off and extended service-life and FPM seals for maximum protection against external leakage.

For maximum versatility, both A and B type valves shall have interchangeable bonnet/stem assemblies.

Needle valves are intended for use in applications that require precise metering control. Needle valves shall have predictable flow patterns with (8) molded in increments on the body. These valves shall have PTFE seats and FPM seals for maximum service life and protection against external leakage. Needle valves have NPS ¼ internal pipe threaded ends.

Chemcock valves are intended for use in laboratory sampling applications. The Chemcock valves have NPS ¼ external thread-by-external thread-end connections; however, one end of the valve shall be capable of being changed to hose-threads for maximum versatility.

Pressure Ratings:

Valves shall be rated for 150 psi at 73° F non-shock water service and have a minimum burst requirement of 3.3 times the rated pressure.

Markings:

Valves shall be clearly marked with the manufacturer's name or trademark, nominal size, material designation, and country of manufacture. PVC and CPVC valves shall additionally bear the NSF International certification mark, NSF-pw, (verifying approval for conveyance of potable water).

Installation:

At the specifying engineer's option, the manufacturer shall provide, at no additional cost, on-site training for installation/maintenance personnel. Otherwise, installation shall be as specified by the manufacturer's printed instructions.

Chemtrol One-Year Limited Warranty

CHEMTROL[®] warrants each CHEMTROL pressure-rated Pipe, Valve, and Industrial Plastic Fitting to be free from defects in materials and workmanship for a period of one (1) year from the date of purchase under normal use and service within limitations recommended by it.

In the event any defect occurs which the owner believes is covered by this Warranty, the owner should immediately contact the authorized CHEMTROL distributor. The owner will be instructed to return said product at the owner's expense to CHEMTROL or an authorized CHEMTROL representative for inspection. In the event said inspection discloses to CHEMTROL's satisfaction that said product is defective, appropriate action relating to credit or replacement shall be initiated.

THIS WARRANTY SPECIFICALLY EXCLUDES INCIDENTAL AND CONSEQUENTIAL DAMAGES OF EVERY TYPE AND DESCRIPTION RESULTING FROM ANY CLAIMED DEFECT IN MATERIAL OR WORKMANSHIP INCLUDING, BUT NOT LIMITED TO, PERSONAL INJURIES AND PROPERTY DAMAGES. Some states do not allow the exclusion or limitations of incidental or consequential damages so these limitations may not apply to you.

TO THE EXTENT PERMITTED BY LAW, IMPLIED WARRANTIES OF MERCHANTABILITY AND FITNESS FOR A PARTICULAR PURPOSE ARE LIMITED IN DURATION TO ONE (1) YEAR FROM THE TIME OF PURCHASE OF SAID VALVE OR FITTING. Some states do not allow limitations in how long an implied warranty lasts, so the above limitations may not apply to you.

This Warranty gives you specific legal rights, and you may also have other rights which vary from state to state.

How to Order

Chemtrol sells its products through select stocking distributors. Our distributors are knowledgeable of plastic applications as well as schooled in the complete CHEMTROL product line. **Please call 800-343-5455, for a listing of distributors in your area.**

NIBCO INC. Customer Service

World Headquarters
1516 Middlebury Street
P.O. Box 1167
Elkhart, IN 46515-1167 Phone: 800.343.5455
U.S.A. Fax: 800.541.3841

To the best of our knowledge the information contained in this publication is accurate. However NIBCO[®]/Chemtrol[®] does not assume any liability whatsoever for the accuracy or completeness of such information. Final determination of the suitability of any information or product for the use to be contemplated is the sole responsibility of the user. The manner of that use and whether there is any infringement of patents is also the sole responsibility of the user.

Technical Service

Our Technical Service Department is available to provide information and guidance on the suitability of CHEMTROL products for specific applications. Recommendations and assistance are also available to engineering and contracting firms for installation specifications and personnel training.

Technical Service:	International Service:
Phone: 888.446.4226	Phone: +1.219.295.3221
Fax: 888.336.4226	Fax: +1.219.295.3455

www.nibco.com/chemtrol

Chemtrol[®] is a brand of **NIBCO**[®]

Ideas
that flow.
Chemtrol®

Chem-Aire® is a registered trademark of NIBCO INC.
Corzan® is a registered trademark of The BF Goodrich Co.
Safety Vent® is a registered trademark of NIBCO INC.
TruConnect® is a trademark of NIBCO INC.
TruBloc® is a registered trademark of NIBCO INC.
Chem-Pure® is a registered trademark of NIBCO INC.
Viton® is a registered trademark of DuPont Dow Elastomers.
Fluorel® is a registered trademark of 3M Company
Kynar®, a registered trademark of ATOFINA Chemicals Inc.
Neoprene®, a registered trademark of E.I. DuPont Co.
Teflon®, a registered trademark of E.I. DuPont Co.

Every solution
begins with
a good idea.

We've got ideas that flow directly to solutions for your industrial piping applications. Ideas that make your installations easier and more cost-effective. Ideas that work, and ideas that last. Our ideas are strengthened by a sound foundation for growth and a solid commitment to service.

For ideas that fit your flow-control applications, call on us. We're Chemtrol, a product line committed to innovation, growth, and superiority in thermoplastics—
ideas whose time has come.

NIBCO INC.
World Headquarters
1516 Middlebury Street
P.O. Box 1167
Elkhart, IN 46515-1167
U.S.A.

Phone: 800.343.5455
Fax: 800.541.3841

Technical Service:
Phone: 888.446.4226

International Service:
Phone: +1.574.295.3221
Fax: +1.574.295.3455

www.nibco.com/chemtrol



C-CHTM-0401